

# Globe-Weis®



PROJECT *Walt Whit*

*Senior. Global Development of new products to  
expand sales*

NO.	NAME	PHONE	CELL	FAX	EMAIL
01	John Smith	555-1234	555-5678	555-9012	john@smith.com
02	Jane Doe	555-3456	555-7890	555-2345	jane@doe.com
03	Robert Brown	555-6789	555-0123	555-4567	rob@brown.com

PROJECT CONTACTS

NAME	PHONE	EMAIL
<i>Jackie</i>	<i>555-0123</i>	<i>jackie@corp.com</i>
<i>Cheryl</i>	<i>555-3456</i>	<i>cheryl@corp.com</i>

*Project Manager*  
*Global Development*

...the project is a success...  
...the project is a success...  
...the project is a success...

file jackets .....71-72  
expanding envelopes .....73-74  
file pockets .....75-76  
expanding wallets .....77-78  
expanding files .....79-84  
poly files, portfolios, viewers & folders .....84-89  
pressboard, classification & poly folders .....89-91  
fiberboard storage products .....92-93  
guides .....94-95

Globe

**FILE JACKETS**

**MANILA VERTICAL FILE JACKETS – SINGLE TOPS**

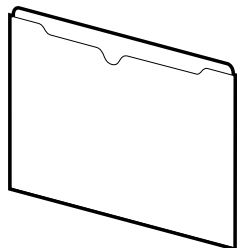

- Durable manila construction
- Full height sides
- Back extends ½" for easy labeling
- Contains 10% post-consumer recycled materials



ITEM NO.	ID NO. 78973 UPC	DESCRIPTION	CTN WT LBS	CTN CUBE	CTN QTY	MIN ORD QTY	U O M
<b>LETTER (9½" x 11¼")</b>							
3010	30100 4	Flat	29.5	1.5	400	100	EA
B3010	30111 0	Flat, Bulk Pack	7.3	0.5	100	100	EA
B3023	30230 8	1" Exp., Bulk Pack	4.7	0.5	50	50	EA
B3033	30336 7	1½" Exp., Bulk Pack	5.2	0.5	50	50	EA
B3043	30431 9	2" Exp., Bulk Pack	5.7	0.5	50	50	EA
<b>LEGAL SIZE (9½" x 14¼")</b>							
B3015	35106 1	Flat, Bulk Pack	9.4	0.6	100	100	EA
B3025	30250 6	1" Exp., Bulk Pack	5.4	0.6	50	50	EA
3035	30350 3	1½" Exp.	25.7	2.6	200	25	EA
B3035	30356 5	1½" Exp., Bulk Pack	5.2	0.6	50	50	EA
B3045	30451 7	2" Exp., Bulk Pack	5.2	0.6	50	50	EA

**MANILA VERTICAL PROJECT JACKETS – DOUBLE TOPS**

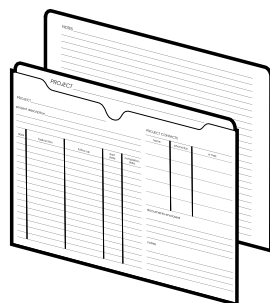

- Project grid printed on front
- Notes section printed on back
- Double-top reinforced tabs
- Durable manila construction
- Full height sides
- Back extends ½" for easy labeling
- Contains 10% post-consumer recycled materials



ITEM NO.	ID NO. 78973 UPC	DESCRIPTION	CTN WT LBS	CTN CUBE	CTN QTY	MIN ORD QTY	U O M
<b>LETTER (9½" x 11¼")</b>							
B3110DT	31100 3	Flat, Bulk Pack (100/box)	7.6	0.5	1	1	BX
B3143DT	31430 1	2" Exp., Bulk Pack (50/box)	5.5	0.5	1	1	BX
<b>LEGAL SIZE (9½" x 14¼")</b>							
B3115DT	31105 8	Flat, Bulk Pack (100/box)	10.1	0.6	1	1	BX
B3145DT	31450 9	2" Exp., Bulk Pack (50/box)	5.9	0.5	1	1	BX

**MANILA VERTICAL FILE JACKETS – DOUBLE TOPS**

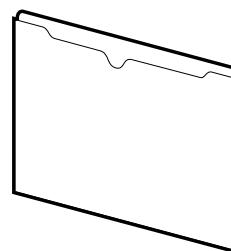

- Double-top reinforced tabs
- Durable manila construction
- Full height sides
- Back extends ½" for easy labeling
- Contains 10% post-consumer recycled materials



ITEM NO.	ID NO. 78973 UPC	DESCRIPTION	CTN WT LBS	CTN CUBE	CTN QTY	MIN ORD QTY	U O M
<b>LETTER (9½" x 11¼")</b>							
B3010DT	30112 7	Flat, Bulk Pack	7.6	0.5	100	100	EA
3010DT10	31010 5	Flat, 10/Pack	8.0	0.4	10	10	PK
3010DT25	30025 0	Flat, 25/Pack	19.8	0.9	10	10	PK
B3023DT	30232 2	1" Exp., Bulk Pack	4.8	0.5	50	50	EA
B3033DT	30337 4	1½" Exp., Bulk Pack	5.4	0.5	50	50	EA
3033DT10	31330 4	1½" Exp., 10/Pack	10.1	0.8	10	10	PK
3033DT25	33025 7	1½" Exp., 25/Pack	14.8	1.0	6	6	PK
20043	20043 7	2" Exp., 10/Pack	5.8	0.5	6	6	PK
3043DT	30432 6	2" Exp.	25.2	2.2	200	25	EA
B3043DT	30438 8	2" Exp., Bulk Pack	5.5	0.5	50	50	EA
3043DT10	34310 3	2" Exp., 10/Pack	10.3	0.8	10	10	PK
3043DT25	34325 7	2" Exp., 25/Pack	15.0	1.1	6	6	PK
<b>LEGAL SIZE (9½" x 14¼")</b>							
3015DT	30152 3	Flat	42.3	1.8	400	100	EA
B3015DT	35107 8	Flat, Bulk Pack	10.1	0.6	100	100	EA
3015DT10	35100 9	Flat, 10/Pack	10.1	0.6	10	10	PK
B3025DT	30252 0	1" Exp., Bulk Pack	5.6	0.6	50	50	EA
B3035DT	30357 2	1½" Exp., Bulk Pack	6.3	0.6	50	50	EA
3035DT10	33510 8	1½" Exp., 10/Pack	11.6	1.0	10	10	PK
3045DT	30452 4	2" Exp.	30.1	2.6	200	25	EA
B3045DT	30459 3	2" Exp., Bulk Pack	5.9	0.5	50	50	EA
3045DT10	34510 7	2" Exp., 10/Pack	13.1	1.0	10	10	PK

## COLORED VERTICAL FILE JACKETS – DOUBLE TOPS

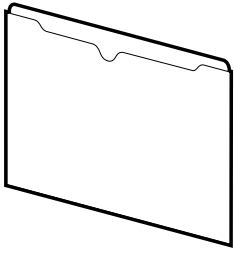

- Assorted colors: blue, green, red, yellow and white
- Durable manila construction
- Full height sides
- Back extends 1/2" for easy labeling
- Contains 10% post-consumer recycled materials



ITEM NO.	ID NO. 78973 UPC	DESCRIPTION	CTN WT LBS	CTN CUBE	CTN QTY	MIN ORD QTY	U O M
<b>LETTER (9 1/2" x 11 1/2")</b>							
3010DT10 ASST	31016 7	Flat, 10/Pack, Assorted	17.5	0.7	20	20	PK
3033DT10 ASST	31336 6	1 1/2" Exp., 10/Pack, Assorted	11.2	0.8	10	10	PK
3043DT10 ASST	34316 5	2" Exp., 10/Pack, Assorted	10.4	0.8	10	10	PK
3043DT BLU	30440 1	2" Exp., Blue	24.2	2.2	200	25	EA
3043DT GRE	30441 8	2" Exp., Green	24.2	2.2	200	25	EA
3043DT RED	30442 5	2" Exp., Red	24.2	2.2	200	25	EA
3043DT YEL	30443 2	2" Exp., Yellow	24.2	2.2	200	25	EA
37000	37000 0	3 Ring Binder Jackets, 10/Pack, Assorted	16.3	0.7	20	20	PK
<b>LEGAL (9 1/2" x 14 1/2")</b>							
3045DT BLU	30444 9	2" Exp., Blue	29.0	2.6	200	25	EA
3045DT GRE	30445 6	2" Exp., Green	29.0	2.6	200	25	EA
3045DT RED	30446 3	2" Exp., Red	29.0	2.6	200	25	EA
3045DT YEL	30447 0	2" Exp., Yellow	29.0	2.6	200	25	EA

## 100% RECYCLED MANILA VERTICAL FILE JACKETS – DOUBLE TOPS

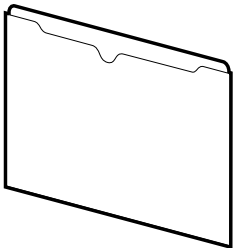

- Double-top reinforced tabs
- Durable manila construction
- Full height sides
- Back extends 1/2" for easy labeling
- Contains 100% recycled materials



ITEM NO.	ID NO. 78973 UPC	DESCRIPTION	CTN WT LBS	CTN CUBE	CTN QTY	MIN ORD QTY	U O M
<b>LETTER (9 1/2" x 11 1/2")</b>							
30109	30109 7	Flat, 10/Pk	12.5	0.4	10	10	PK
30339	30339 8	1 1/2" Exp., 10/Pk + 2 FREE	11.1	0.9	10	10	PK
30359	30359 6	2" Exp., 10/Pk + 2 FREE	12.4	0.9	10	10	PK
<b>LEGAL (9 1/2" x 14 1/2")</b>							
30119	30119 6	Flat, 10/Pk	9.6	0.5	10	10	PK
30349	30349 7	1 1/2" Exp., 10/Pk + 2 FREE	11.4	1.2	10	10	PK
30369	30369 5	2" Exp., 10/Pk + 2 FREE	13.3	1.2	10	10	PK

## SLASH JACKETS

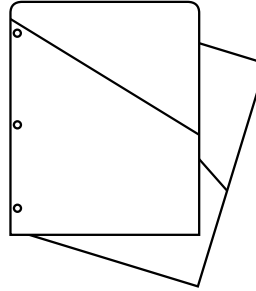

- Durable manila construction
- Slash front for easy viewing and access to contents
- Contains 10% post-consumer recycled materials



ITEM NO.	ID NO. 78973 UPC	DESCRIPTION	CTN WT LBS	CTN CUBE	CTN QTY	MIN ORD QTY	U O M
<b>LETTER (9 1/2" x 11 1/2")</b>							
37010	37010 9	10/Pack, Manila	6.5	0.4	10	10	PK
37020	37020 8	3 Hole Punched, 10/Pack, Blue	7.1	0.4	10	10	PK
37026	37026 0	10/Pack, Assorted	7.1	0.4	10	10	PK

## MANILA 1" EXPANDING FOLDER

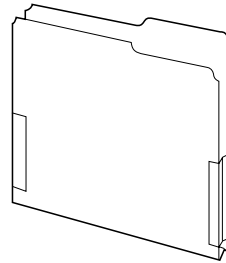

- Durable manila stock
- Tyvek® tape gussets
- Tab for easy access and filing
- Contains 10% post-consumer recycled materials



ITEM NO.	ID NO. 78973 UPC	DESCRIPTION	CTN WT LBS	CTN CUBE	CTN QTY	MIN ORD QTY	U O M
<b>LETTER (10" x 11 1/2")</b>							
GUSSET661 2/5 1	66125 2	1" Exp.	23.0	1.3	250	50	EA

**EXPANDING ENVELOPES**

**LINEN ENVELOPES**

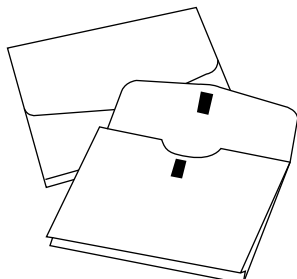

- Velcro® closure
- 2" expansion
- Linen embossed paper, assorted colors: burgundy, blue and black
- Contains 30% recycled materials



ITEM NO.	ID NO. 78973 UPC	DESCRIPTION	CTN WT LBS	CTN CUBE	CTN QTY	MIN ORD QTY	U O M
<b>LETTER (9½" X 11¾")</b>							
30310	30310 7	Assorted Colors	3.6	0.3	24	24	EA
<b>LEGAL (10" X 15")</b>							
40410	40410 1	Assorted Colors	4.0	0.5	24	24	EA

**EZY-LOCK® ENVELOPES**

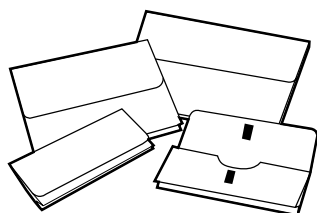

- Velcro® closure
- 2" expansion
- Assorted: red, blue and gray
- Contains 10% post-consumer recycled materials



ITEM NO.	ID NO. 78973 UPC	DESCRIPTION	CTN WT LBS	CTN CUBE	CTN QTY	MIN ORD QTY	U O M
<b>NOTE (4½" X 10¾")</b>							
20209	20209 7	Assorted	2.0	0.2	24	24	EA
<b>LETTER (9½" X 11¾")</b>							
30309	30309 1	Assorted	3.6	0.3	24	24	EA
<b>LEGAL (10" X 15")</b>							
40409	40409 5	Assorted	4.8	0.5	24	24	EA

**ENVELOPES WITH ELASTIC CORD CLOSURES**

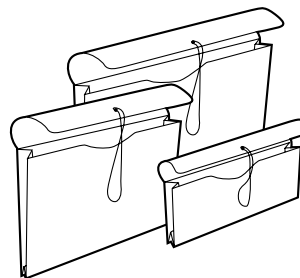

- Elastic cord closure
- 2" expansion
- Contains 10% post-consumer recycled materials



ITEM NO.	ID NO. 78973 UPC	DESCRIPTION	CTN WT LBS	CTN CUBE	CTN QTY	MIN ORD QTY	U O M
<b>NOTE (4½" X 10¾")</b>							
20400	20400 8	Letha-Tone®, 4/Pack	3.9	0.3	12	12	PK
MM20	00200 0	Letha-Tone®	2.0	0.2	24	24	EA
<b>LETTER (9½" X 11¾")</b>							
MM30	00300 7	Letha-Tone®	3.4	0.3	24	24	EA
<b>LEGAL (10" X 15")</b>							
40405	40405 7	Assorted, 4/Pack	9.1	0.7	12	12	PK
MM40	00400 4	Letha-Tone®	4.5	0.4	24	24	EA

**RED WALLET ENVELOPES WITH TIE CLOSURES**

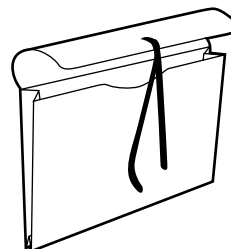

- Red wallet stock
- Classic tie closure
- 2" expansion
- Contains 10% post-consumer recycled materials



ITEM NO.	ID NO. 78973 UPC	DESCRIPTION	CTN WT LBS	CTN CUBE	CTN QTY	MIN ORD QTY	U O M
<b>LETTER (9½" x 11¾")</b>							
MM6043	06043 7	2" Expansion	6.8	0.6	48	48	EA
<b>LEGAL (10" x 15")</b>							
MM6046	06046 8	2" Expansion	8.5	0.9	48	48	EA

## GLOBALFILE® POLY TOP-OPENING ENVELOPES

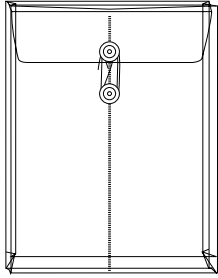

- Top-opening
- Durable polypropylene
- Expands up to 1"
- Translucent clear or assort packs: blue, yellow, green, purple, clear
- String and button closure.

ITEM NO.	ID NO. 78973 UPC	DESCRIPTION	CTN WT LBS	CTN CUBE	CTN QTY	MIN ORD QTY	U O M
<b>LETTER (9<sup>3</sup>/<sub>4</sub>" x 11<sup>3</sup>/<sub>4</sub>")</b>							
84150	84150 0	Clear	1.4	0.1	12	12	EA
84170	84170 8	Assorted Colors	1.4	0.1	12	12	EA
<b>LEGAL (10<sup>1</sup>/<sub>4</sub>" x 14<sup>1</sup>/<sub>4</sub>")</b>							
84160	84160 9	Clear	1.7	0.1	12	12	EA
84180	84180 7	Assorted Colors	1.7	0.1	12	12	EA

## GLOBALFILE® POLY SIDE-OPENING ENVELOPES

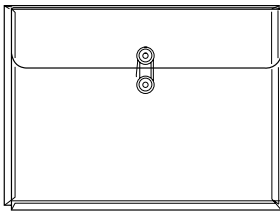

- Side-opening
- Durable polypropylene
- Translucent clear or assort packs: blue, yellow, green, purple
- Expands up to 1"
- String and button closure.

ITEM NO.	ID NO. 78973 UPC	DESCRIPTION	CTN WT LBS	CTN CUBE	CTN QTY	MIN ORD QTY	U O M
<b>LETTER (13" x 9<sup>3</sup>/<sub>4</sub>")</b>							
84181	84181 4	Clear	8.0	0.9	72	12	EA
84182	84182 1	Assorted Colors	8.0	0.9	72	12	EA
84183	84183 8	3/Pack, Assorted	8.0	0.9	24	24	PK
<b>LEGAL (14<sup>1</sup>/<sub>2</sub>" x 10<sup>1</sup>/<sub>4</sub>")</b>							
84185	84185 2	Clear	9.2	1.0	72	12	EA
84187	84187 6	3/Pack, Assorted	9.2	1.0	24	24	PK

## POLYCOLORS™ ENVELOPES

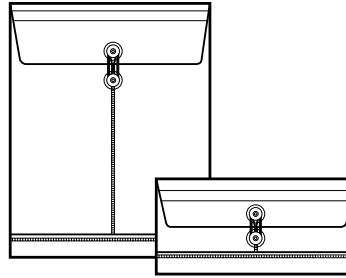

- Top-opening
- Durable polypropylene
- Translucent colored assort packs: blue, red, teal, purple
- Expands to 1"
- String and button closure

ITEM NO.	ID NO. 78973 UPC	DESCRIPTION	CTN WT LBS	CTN CUBE	CTN QTY	MIN ORD QTY	U O M
<b>CHECK (9<sup>1</sup>/<sub>2</sub>" x 4<sup>3</sup>/<sub>4</sub>")</b>							
84171	84171 5	Assorted Colors	1.4	0.1	24	24	EA
<b>LETTER (9<sup>1</sup>/<sub>2</sub>" x 11<sup>3</sup>/<sub>4</sub>")</b>							
84184	84184 5	Assorted Colors	2.3	0.1	24	24	EA

## FILE N STYLE® POLY ENVELOPES

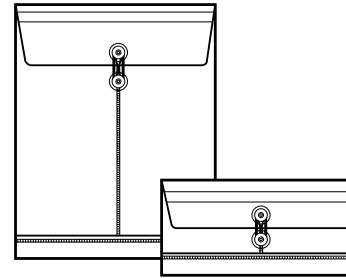

- Durable translucent waterproof poly
- Top-opening and side-opening
- Expands to 1"
- String and button closure
- Assorted fashion colors: cranberry, bronze, slate and mocha

ITEM NO.	ID NO. 78973 UPC	DESCRIPTION	CTN WT LBS	CTN CUBE	CTN QTY	MIN ORD QTY	U O M
<b>CHECK (9<sup>1</sup>/<sub>2</sub>" x 4<sup>3</sup>/<sub>4</sub>")</b>							
84172	84172 2	Assorted Colors	1.0	0.1	12	12	EA
<b>LETTER (9<sup>3</sup>/<sub>4</sub>" x 11<sup>3</sup>/<sub>4</sub>") TOP-OPENING</b>							
84189	84189 0	Assorted Colors	1.4	0.1	12	12	EA

**FILE POCKETS**

**RED ROPE FILE POCKETS WITH MYLAR® REINFORCED GUSSETS**

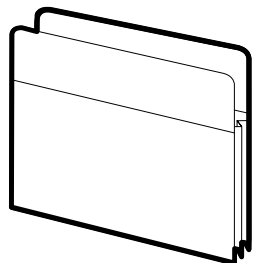

- Five piece construction
- Mylar® reinforced red rope gussets
- Manila lining
- Scored front flap for easy access
- Contains 10% post-consumer recycled materials



ITEM NO.	ID NO. 78973 UPC	DESCRIPTION	CTN WT LBS	CTN CUBE	CTN QTY	MIN ORD QTY	U O M
<b>LETTER (9½" x 11¾")</b>							
1514C	15140	1½" Exp.	18.0	1.1	100	25	EA
B1514C	51410	1½" Exp., Bulk Pack	8.9	0.8	50	50	EA
1514C5	45151	1½" Exp., 5/Pack	9.2	0.7	10	10	PK
1524E	15240	3½" Exp.	19.8	1.6	100	25	EA
B1524E	52411	3½" Exp., Bulk Pack	9.2	0.8	50	50	EA
1524E5	45152	3½" Exp., 5/Pack	11.1	1.0	10	10	PK
1534G	15340	5¼" Exp.	23.2	2.7	100	10	EA
B1534G	53412	5¼" Exp., Bulk Pack	5.2	0.7	25	25	EA
1534G5	45153	5¼" Exp., 5/Pack	11.8	1.0	10	10	PK
<b>LEGAL (9½" x 14¾")</b>							
1516C	15160	1¾" Exp.	22.9	1.2	100	25	EA
B1516C	51610	1¾" Exp., Bulk Pack	10.8	0.8	50	50	EA
1516C5	65151	1¾" Exp., 5/Pack	12.9	0.9	10	10	PK
1526E	15260	3½" Exp.	25.9	1.8	100	25	EA
B1526E	52611	3½" Exp., Bulk Pack	11.4	1.1	50	50	EA
1526E5	65152	3½" Exp., 5/Pack	13.0	1.3	10	10	PK
1536G	15360	5¼" Exp.	14.5	1.9	50	10	EA
B1536G	53612	5¼" Exp., Bulk Pack	6.5	0.9	25	25	EA
1536G5	65153	5¼" Exp., 5/Pack	13.6	1.3	10	10	PK

**RED ROPE FILE POCKETS WITH TYVEK® TEAR RESISTANT GUSSETS**

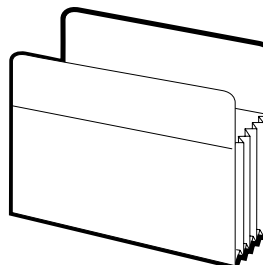

- Five-piece construction
- Manila lining
- Scored front flap for easy access
- Tear resistant Tyvek® gussets
- Contains 10% post-consumer recycled materials



ITEM NO.	ID NO. 78973 UPC	DESCRIPTION	CTN WT LBS	CTN CUBE	CTN QTY	MIN ORD QTY	U O M
<b>LETTER (9½" x 11¾")</b>							
C1514C	15143	2 1¾" Exp.	20.1	1.6	100	25	EA
C1524E	15243	9 3½" Exp.	22.2	1.8	100	25	EA
C1524E5	15249	1 3½" Exp., 5/Pack	11.4	1.1	10	10	PK
C1534G	15343	6 5¼" Exp.	24.8	2.7	100	10	EA
C1534G5	15349	8 5¼" Exp., 5/Pack	12.1	1.2	10	10	PK
15444	15444	0 7" Exp.	21.0	2.6	50	5	EA
<b>LEGAL (9½" x 14¾")</b>							
C1516C	15163	0 1¾" Exp.	25.5	1.8	100	25	EA
C1526E	15263	7 3½" Exp.	27.9	2.8	100	25	EA
C1526E5	15269	9 3½" Exp., 5/Pack	13.7	1.4	10	10	PK
C1536G	15363	4 5¼" Exp.	15.3	1.9	50	10	EA
C1536G5	15369	6 5¼" Exp., 5/Pack	14.8	1.5	10	10	PK
15446	15446	4 7" Exp.	13.4	1.8	25	5	EA

**XTRALIFE® FILE POCKETS**

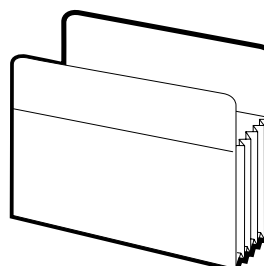

- Tyvek® exterior seal on front and back panel and gussets
- Tear and moisture resistant
- Five piece construction
- Triple-ply exterior panels
- Scored front flap for easy access
- Contains 10% post-consumer recycled material



ITEM NO.	ID NO. 78973 UPC	DESCRIPTION	CTN WT LBS	CTN CUBE	CTN QTY	MIN ORD QTY	U O M
<b>LETTER (9½" x 11¾")</b>							
15224	15224	8 3½" Exp., 4/Pk	12.2	0.9	10	10	PK
15214	15214	9 5¼" Exp., 4/Pk	13.6	1.2	10	10	PK
<b>LEGAL (9½" x 14¾")</b>							
15226	15226	2 3½" Exp., 4/Pk	13.6	1.2	10	10	PK
15216	15216	3 5¼" Exp., 4/Pk	16.8	1.4	10	10	PK

**COLORED FILE POCKETS**

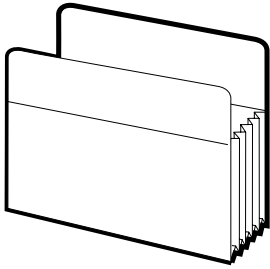

- Five-piece construction
- Manila lining
- Scored front flap for easy access
- Mylar® reinforced gussets
- Contains 10% post-consumer recycled materials



ITEM NO.	ID NO. 78973 UPC	DESCRIPTION	CTN			MIN		U
			WT LBS	CUBE	QTY	ORD QTY	O M	
<b>LETTER (9½" x 11¼")</b>								
1524E BLU	15251 4	3½" Exp., Blue	4.8	0.5	25	25	EA	
1524E GRE	15252 1	3½" Exp., Green	4.8	0.5	25	25	EA	
1524E RED	15253 8	3½" Exp., Red	4.8	0.5	25	25	EA	
1524E YEL	15254 5	3½" Exp., Yellow	4.8	0.5	25	25	EA	
1524E5 ASST	15425 9	3½" Exp. 5/Pack, Assorted	11.3	1.0	10	10	PK	
1534G BLU	15440 2	5¼" Exp., Blue	5.2	0.7	25	25	EA	
1534G GRE	15441 9	5¼" Exp., Green	5.2	0.7	25	25	EA	
1534G RED	15442 6	5¼" Exp., Red	5.1	0.7	25	25	EA	
1534G YEL	15443 3	5¼" Exp., Yellow	5.3	0.7	25	25	EA	
1534G5 ASST	15339 9	5¼" Exp. 5/Pack, Assorted	11.8	1.0	10	10	PK	
<b>LEGAL (9½" x 14¾")</b>								
1526E BLU	15271 2	3½" Exp., Blue	6.1	0.9	25	25	EA	
1526E RED	15273 6	3½" Exp., Red	6.3	0.9	25	25	EA	
1526E5 ASST	15625 3	3½" Exp. 5/Pack, Assorted	13.3	1.3	10	10	PK	
1536G BLU	15640 6	5¼" Exp., Blue	6.8	0.9	25	25	EA	
1536G GRE	15641 3	5¼" Exp., Green	6.3	0.80	25	25	EA	
1536G RED	15642 0	5¼" Exp., Red	6.3	0.80	25	25	EA	
1536G YEL	15643 7	5¼" Exp., Yellow	6.8	0.9	25	25	EA	
1536G5 ASST	15379 5	5¼" Exp. 5/Pack, Assorted	13.6	1.3	10	10	PK	

**MARBLED FILE POCKETS**

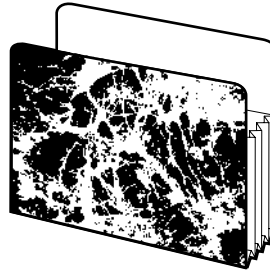

- Laminated, matte-finish, water-resistant exterior panels
- Black gussets and lining
- Five piece construction
- Mylar® reinforced gussets
- Assorted packs contain red, blue and black marbled pockets
- Contains 10% post-consumer recycled material



ITEM NO.	ID NO. 78973 UPC	DESCRIPTION	CTN			MIN		U
			WT LBS	CUBE	QTY	ORD QTY	O M	
<b>LETTER (9½" x 11¾")</b>								
35425	35425 3	3½" Exp., 4/Pack, Assorted	12.2	0.9	10	10	PK	
35427	35427 7	3½" Exp., Red	5.0	0.5	25	25	EA	
35428	35428 4	3½" Exp., Blue	5.0	0.5	25	25	EA	
35429	35429 1	3½" Exp., Black	5.0	0.5	25	25	EA	
<b>LEGAL (9½" x 14¾")</b>								
35627	35627 1	3½" Exp., Red	6.3	0.8	25	25	EA	
35628	35628 8	3½" Exp., Blue	6.3	0.8	25	25	EA	
35629	35629 5	3½" Exp., Black	6.3	0.8	25	25	EA	

**EXPANDING WALLETS**

**RED ROPE EXPANDING WALLETS WITH MYLAR® REINFORCED GUSSETS**

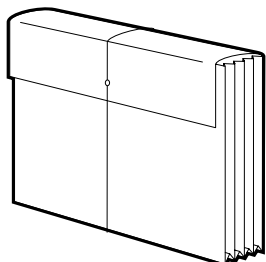

- Sturdy red rope stock
- Red rope gussets with mylar reinforcement
- Five piece construction
- Two-ply, scored flap with rounded corners
- Elastic cord closure
- Contains 10% post-consumer recycled material



ITEM NO.	ID NO. 78973 UPC	DESCRIPTION	CTN WT LBS	CTN CUBE	CTN QTY	MIN ORD QTY	U O M
<b>DRAFT (5" x 11")</b>							
1049E3	10493 3	3½" Exp., 3/Pack	10.8	1.0	20	20	PK
<b>LETTER (9½" x 11¾")</b>							
B1033C	13301 8	1¾" Exp., Bulk Pack	6.2	0.7	25	25	EA
1053E	10530 5	3½" Exp.	31.5	3.7	100	10	EA
B1053E	15301 6	3½" Exp., Bulk Pack	6.8	0.8	25	25	EA
1073G	10730 9	5¼" Exp.	35.0	3.7	100	10	EA
B1073G	11739 1	5¼" Exp., Bulk Pack	7.6	0.8	25	25	EA
1073G3	10732 3	5¼" Exp., 3/Pack	11.4	1.1	10	10	PK
<b>LEGAL (9½" x 14¾")</b>							
1055E3	10557 2	3½" Exp., 3/Pack	17.0	1.9	15	15	PK
1075G	10750 7	5¼" Exp.	21.9	2.5	50	10	EA
1075G3	10753 8	5¼" Exp., 3/Pack	14.5	1.9	10	10	PK
<b>ATTORNEY (10" x 15")</b>							
B1036C	13601 9	1¾" Exp., Bulk Pack	8.2	1.0	25	25	EA
1056E	10560 2	3½" Exp.	20.3	2.5	50	10	EA
B1056E	15638 3	3½" Exp., Bulk Pack	8.5	1.0	25	25	EA
1056E5	10565 7	3½" Exp., 5/Pack	18.3	1.8	10	10	PK
1076G	10760 6	5¼" Exp.	22.6	2.5	50	10	EA
B1076G	11769 8	5¼" Exp., Bulk Pack	9.4	1.0	25	25	EA
1076G5	10768 2	5¼" Exp., 5/Pack	19.3	2.4	10	10	PK
<b>EXTRA LARGE (12" x 18")</b>							
1060E2	10602 9	3½" Exp., 2/Pack	15.4	1.6	15	15	PK

**RED ROPE EXPANDING WALLETS WITH TYVEK® TEAR RESISTANT GUSSETS**

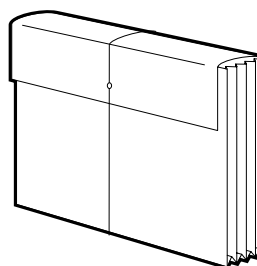

- Five piece construction
- Two-ply scored flap with rounded corners
- Elastic cord closure
- Tear resistant Tyvek® gussets
- Contains 10% post-consumer recycled material



ITEM NO.	ID NO. 78973 UPC	DESCRIPTION	CTN WT LBS	CTN CUBE	CTN QTY	MIN ORD QTY	U O M
<b>LETTER (9½" x 11¾")</b>							
C1053E	10534 3	3½" Exp.	32.6	3.4	100	10	EA
C1053E3	10539 8	3½" Exp., 3/Pack	14.9	1.5	15	15	PK
C1073G	10734 7	5¼" Exp.	36.7	3.4	100	10	EA
C1073G3	10733 0	5¼" Exp., 3/Pack	11.8	1.4	10	10	PK
<b>LEGAL (9½" x 14¾")</b>							
C1055E	10554 1	3½" Exp.	18.8	2.3	50	10	EA
<b>ATTORNEY (10" x 15")</b>							
C1056E	10564 0	3½" Exp.	19.9	2.4	50	10	EA
C1056E3	10566 4	3½" Exp., 3/Pack	18.9	1.9	15	15	PK
C1076G	10764 4	5¼" Exp.	22.3	2.4	50	10	EA
C1076G3	10763 7	5¼" Exp., 3/Pack	14.35	1.9	10	10	PK

**EXPANDING WALLETS WITH SOIL RESISTANT COVERS**

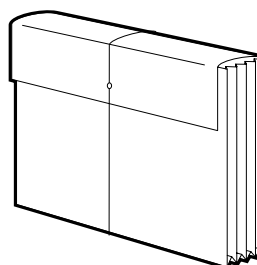

- Soil-resistant Letha-Tone® covers
- Five-piece construction
- Two-ply scored flap with rounded corners
- Elastic cord closure
- Mylar® reinforced gussets or Tyvek® tear resistant gussets
- Contains 10% post-consumer recycled material



ITEM NO.	ID NO. 78973 UPC	DESCRIPTION	CTN WT LBS	CTN CUBE	CTN QTY	MIN ORD QTY	U O M
<b>LETTER (9½" x 11¾")</b>							
E1053E	10533 6	Mylar® Gusset, 3½" Exp.	32.6	3.7	100	10	EA
EC1053E	10532 9	Tyvek® Gusset, 3½" Exp.	31.8	3.7	100	10	EA
EC1053E3	10529 9	Tyvek® Gusset, 3½" Exp., 3/Pk	14.9	1.3	15	15	PK
<b>LEGAL (10" x 15")</b>							
E1056E	10563 3	Mylar® Gusset, 3½" Exp.	20.4	2.4	50	10	EA
EC1056E	10562 6	Tyvek® Gusset, 3½" Exp.	21.1	2.4	50	10	EA
EC1056E3	10559 6	Tyvek® Gusset, 3½" Exp., 3/Pk	19.5	2.3	15	15	PK

## XTRALIFE® EXPANDING WALLETS

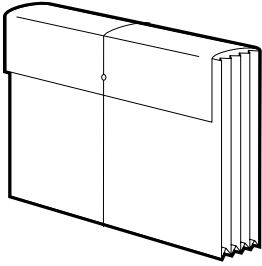

- Tyvek® exterior seal on front and back panels, flap and gussets
- Tear and moisture resistant
- Five piece construction
- Triple-ply exterior panels
- Scored flap with rounded corners
- Brown elastic cord closure
- Contains 10% post-consumer recycled materials



ITEM NO.	ID NO. 78973 UPC	DESCRIPTION	CTN WT LBS	CTN CUBE	CTN QTY	MIN ORD QTY	U O M
<b>LETTER (9½" x 11¾")</b>							
10513	10513 8	3½" Exp., 3/Pk	15.2	1.60	10	10	PK
10523	10523 7	5½" Exp., 3/Pk	15.9	1.41	10	10	PK
<b>LEGAL (10" x 15")</b>							
10516	10516 9	3½" Exp., 3/Pk	20.1	1.89	10	10	PK
10526	10526 3	5½" Exp., 3/Pk	20.5	1.89	10	10	PK

## COLORED EXPANDING WALLETS

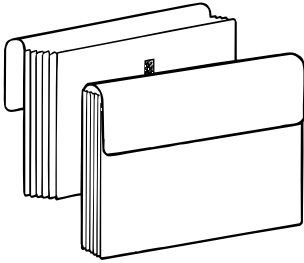

- Glossy, water-resistant film laminate surface
- Mylar® reinforced gussets
- Protective flap
- Velcro® closure
- Contains 10% post-consumer recycled materials



ITEM NO.	ID NO. 78973 UPC	DESCRIPTION	CTN WT LBS	CTN CUBE	CTN QTY	MIN ORD QTY	U O M
<b>LETTER (9½" x 11¾")</b>							
12530	12530 3	3½" Exp., Blue	4.0	0.5	10	10	EA
32530	32530 7	3½" Exp., Blue, 3/Pack	10.2	1.1	10	10	PK
12531	12531 0	3½" Exp., Red	4.0	0.5	10	10	EA
12532	12532 7	3½" Exp., Teal	4.0	0.5	10	10	EA
12533	12533 4	3½" Exp., Yellow	4.0	0.5	10	10	EA
<b>LEGAL (10" x 15")</b>							
12560	12560 0	3½" Exp., Blue	4.3	0.5	10	10	EA
12561	12561 7	3½" Exp., Red	4.0	0.5	10	10	EA
12562	12562 4	3½" Exp., Teal	4.5	0.5	10	10	EA
12563	12563 1	3½" Exp., Yellow	4.0	0.5	10	10	EA

## MARBLED EXPANDING WALLETS

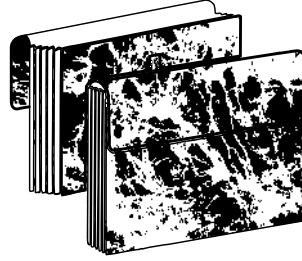

- Matte, water-resistant, laminated covers
- Mylar® reinforced black gussets
- Velcro® closures
- Assort pack contains 4 red, 3 blue, 3 black
- Contains minimum 10% post-consumer recycled materials



ITEM NO.	ID NO. 78973 UPC	DESCRIPTION	CTN WT LBS	CTN CUBE	CTN QTY	MIN ORD QTY	U O M
<b>LETTER (9½" x 11¾")</b>							
32440	32440 9	3½" Exp., Blue	4.1	0.6	10	10	EA
32441	32441 6	3½" Exp., Red	4.1	0.6	10	10	EA
32443	32443 0	3½" Exp., Black	4.1	0.6	10	10	EA
32445	32445 4	3½" Exp., Assorted Colors	4.1	0.6	10	10	EA
<b>LEGAL (10" x 15")</b>							
32450	32450 8	3½" Exp., Blue	4.3	0.7	10	10	EA
32451	32451 5	3½" Exp., Red	4.3	0.7	10	10	EA
32453	32453 9	3½" Exp., Black	4.3	0.7	10	10	EA
32455	32455 3	3½" Exp., Assorted Colors	4.3	0.7	10	10	EA

## RED ROPE EXPANDING PARTITION WALLETS

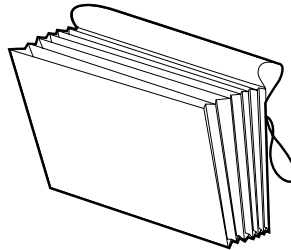

- Five piece construction
- Two-ply flap with rounded corners
- Elastic cord closure
- Convenient organizing partitions
- Mylar® reinforced gussets or Tyvek® tear resistant gussets
- Contains 10% post-consumer recycled materials



ITEM NO.	ID NO. 78973 UPC	DESCRIPTION	CTN WT LBS	CTN CUBE	CTN QTY	MIN ORD QTY	U O M
<b>LETTER (9½" x 11¾")</b>							
1373G	13730 6	Mylar® Gusset, 6 Pkts, 5½" Exp.	19.0	1.6	30	10	EA

**EXPANDING FILES**

**KRAFT EXPANDING FILES WITH FLAP**

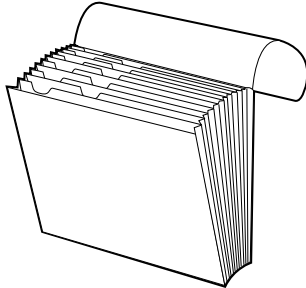

- All-kraft construction
- Protective flaps
- Mylar® reinforced gussets
- Visible printed indexes
- Elastic cord closure optional
- Contains 10% post-consumer recycled materials



ITEM NO.	ID NO. 78973 UPC	DESCRIPTION	CTN WT LBS	CTN CUBE	CTN QTY	MIN ORD QTY	U O M
1807A	18070 8	<b>A-Z, ALPHABETICAL (DRAFT 4<sup>3</sup>/<sub>4</sub>" x 9<sup>1</sup>/<sub>2</sub>" )</b> 21 Pockets	6.9	0.7	10	10	EA
1815A	18151 4	<b>A-Z, ALPHABETICAL (NOTE 6" x 11<sup>1</sup>/<sub>2</sub>" )</b> 21 Pockets	22.6	2.31	24	24	EA
1817A	18170 5	<b>A-Z, ALPHABETICAL (LETTER 10" x 12")</b> 21 Pockets	16.3	1.4	10	10	EA
B1817A	18178 1	21 Pockets, Bulk Pack	14.7	1.2	10	10	EA
1817AE	18171 2	21 Pockets w/Elastic Cord Closure	16.2	1.4	10	10	EA
1819A	18192 7	<b>A-Z, ALPHABETICAL (LEGAL 10" x 15")</b> 21 Pockets	19.6	1.9	10	10	EA
B1819A	18191 0	21 Pockets, Bulk Pack	18.2	2.0	10	10	EA
1819AE	18190 3	21 Pockets w/Elastic Cord Closure	19.6	1.9	10	10	EA
1817M	18173 6	<b>JAN-DEC, MONTHLY (LETTER 10" x 12")</b> 12 Pockets	12.0	1.2	10	10	EA
1819M	18194 1	<b>JAN-DEC, MONTHLY (LEGAL 10" x 15")</b> 12 Pockets	18.5	1.7	12	12	EA
1817D	18172 9	<b>1-31, DAILY (LETTER 10" x 12")</b> 31 Pockets	21.6	2.4	10	10	EA
1819D	18193 4	<b>1-31, DAILY (LEGAL 10" x 15")</b> 31 Pockets	26.2	2.7	10	10	EA

**LETHA-TONE® EXPANDING FILES WITHOUT FLAPS**

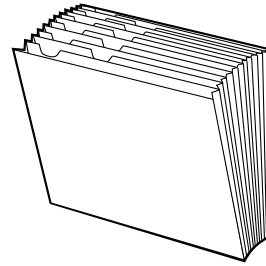

- Durable red rope indexes and gussets
- Soil-resistant Letha-Tone® cover
- Open top for easy access
- Double top pre-printed indexes
- Mylar® reinforced gussets
- Contains 10% post-consumer recycled materials



ITEM NO.	ID NO. 78973 UPC	DESCRIPTION	CTN WT LBS	CTN CUBE	CTN QTY	MIN ORD QTY	U O M
17A	17002 0	<b>A-Z, ALPHABETICAL (LETTER 10" x 12")</b> 21 Pockets	16.6	1.6	10	10	EA
19A	00193 5	<b>A-Z, ALPHABETICAL (LEGAL 10" x 15")</b> 21 Pockets	20.1	1.8	10	10	EA
17M	17004 4	<b>JAN-DEC, MONTHLY (LETTER 10" x 12")</b> 12 Pockets	11.4	1.2	10	10	EA
19M	00195 9	<b>JAN-DEC, MONTHLY (LEGAL 10" x 15")</b> 12 Pockets	13.6	1.4	10	10	EA
17D	17003 7	<b>1-31, DAILY (LETTER 10" x 12")</b> 31 Pockets	22.1	2.5	10	10	EA
19D	00194 2	<b>1-31, DAILY (LEGAL 10" x 15")</b> 31 Pockets	26.8	2.7	10	10	EA

## LETHA-TONE® EXPANDING FILES WITH FLAPS

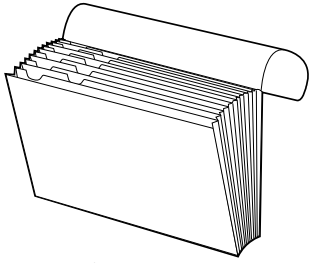

- Soil-resistant Letha-Tone® Cover
- Flap protects contents
- Durable red rope indexes and gussets
- Mylar® reinforced gussets
- Double top pre-printed indexes
- Contains 10% post-consumer recycled materials



ITEM NO.	ID NO. 78973 UPC	DESCRIPTION	CTN WT LBS	CTN CUBE	CTN QTY	MIN ORD QTY	U O M
<b>A-Z, ALPHABETICAL (LETTER 10" x 12")</b>							
1917A	19171 1	21 Pockets	17.0	1.6	10	10	EA
MM517AE	51700 9	16 Pockets, Elastic Cord Closure	7.7	0.8	6	6	EA
<b>A-Z, ALPHABETICAL (LEGAL 10" x 15")</b>							
1919A	19190 2	21 Pockets	20.6	2.0	10	10	EA
<b>MON-SUN, WEEKLY (LETTER 10" x 12")</b>							
1917W	19173 5	8 Pocket, Elastic Cord Closure, Weekly Planner Guide Printed on Flap	9.5	1.0	10	10	EA

## XTRALIFE® EXPANDING FILES WITH FLAPS

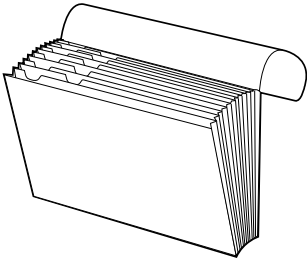

- Tyvek® exterior seal on front and back panels, flap and gussets
- Tear and moisture resistant
- Triple-ply exterior panels
- Double top pre-printed indexes
- Brown elastic cord closure
- Contains 10% post-consumer recycled materials



ITEM NO.	ID NO. 78973 UPC	DESCRIPTION	CTN WT LBS	CTN CUBE	CTN QTY	MIN ORD QTY	U O M
<b>A-Z, ALPHABETICAL (LETTER 10" x 12")</b>							
17090	17090 7	21 Pockets	17.0	1.6	10	10	EA
<b>A-Z, ALPHABETICAL (LEGAL 10" x 15")</b>							
17092	17092 1	21 Pockets	20.6	2.0	10	10	EA
<b>JAN-DEC, MONTHLY (LETTER 10" x 12")</b>							
17091	17091 4	12 Pockets	11.9	1.2	10	10	EA
<b>1-31, DAILY (LETTER 10" x 15")</b>							
17093	17093 8	31 Pockets	26.4	2.34	10	10	EA

## XTRALIFE® EXPANDING FILES WITHOUT FLAPS

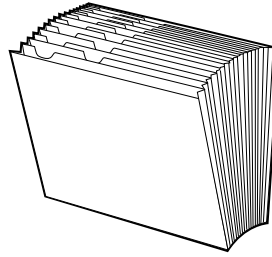

- Tyvek® exterior seal on front and back panels and gussets
- Tear and moisture resistant
- Triple-ply exterior panels
- Double top pre-printed indexes
- Contains 10% post-consumer recycled materials



ITEM NO.	ID NO. 78973 UPC	DESCRIPTION	CTN WT LBS	CTN CUBE	CTN QTY	MIN ORD QTY	U O M
<b>A-Z, ALPHABETICAL (LETTER 10" x 12")</b>							
17070	17070 9	21 Pockets	16.6	1.6	10	10	EA
<b>JAN-DEC, MONTHLY (LETTER 10" x 12")</b>							
17071	17071 6	12 Pockets	11.6	1.2	10	10	EA
<b>1-31, DAILY (LETTER 10" x 12")</b>							
17072	17072 3	31 Pockets	22.1	2.4	10	10	EA
<b>1-31, DAILY (LEGAL 10" x 15")</b>							
17073	17073 0	31 Pockets	26.7	2.7	10	10	EA

## QUICKVUE™ PROJECT FILES

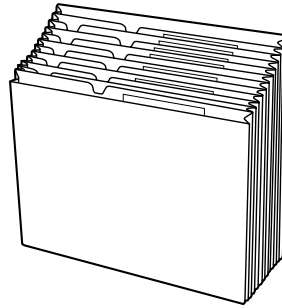

- Unique graduated indexes
- Available in:
  - Blue color covers
  - Professional Letha-Tone® covers (soil-resistant)
- Double-top indexes pre-printed
- Stores neatly in overhead binder bins or bookshelves
- Contains 10% post-consumer recycled materials



ITEM NO.	ID NO. 78973 UPC	DESCRIPTION	CTN WT LBS	CTN CUBE	CTN QTY	MIN ORD QTY	U O M
<b>1-12 (LETTER 11½" x 12")</b>							
20131	20131 1	Graduated Indexes, 12 Pkts, Blue	8.8	1.0	10	10	EA
20141	20141 0	Graduated Indexes, 12 Pkts, Letha-Tone®	8.8	1.0	10	10	EA
<b>A-Z, ALPHABETICAL (LETTER 11½" x 12")</b>							
20134	20134 2	Graduated Indexes, 12 Pkts, Blue	8.8	1.0	10	10	EA
20144	20144 1	Graduated Indexes, 12 Pkts, Letha-Tone®	8.8	1.0	10	10	EA
<b>JAN. - DEC., MONTHLY (LETTER 11½" x 12")</b>							
20135	20135 9	Graduated Indexes, 12 Pkts, Blue	8.8	1.0	10	10	EA
20145	20145 8	Graduated Indexes, 12 Pkts, Letha-Tone®	8.8	1.0	10	10	EA

**COLORWAVE™ EXPANDING FILES WITHOUT FLAPS**

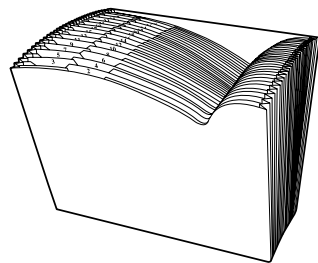

- Wave design for easy access
- Mylar® reinforced pockets
- Fits in file cabinet
- Pre-printed indexes
- Blue or red outside with gray indexes
- Contains 10% post-consumer recycled materials



ITEM NO.	ID NO. 78973 UPC	DESCRIPTION	CTN WT LBS	CTN CTN CUBE	CTN QTY	MIN ORD QTY	U O M
<b>1-31, DAILY (LETTER 10" X 12")</b>							
38450	38450 2	31 Pockets, Blue	22.0	2.3	10	10	EA
38451	38451 9	31 Pockets, Red	22.0	2.3	10	10	EA
<b>A-Z, ALPHABETICAL (LETTER 10" X 12")</b>							
38454	38454 0	21 Pockets, Blue	16.6	1.7	10	10	EA
38455	38455 7	21 Pockets, Red	16.6	1.7	10	10	EA
<b>JAN. - DEC., MONTHLY (LETTER 10" X 12")</b>							
38458	38458 8	13 Pockets, Blue	11.6	1.2	10	10	EA
38459	38459 5	13 Pockets, Red	11.6	1.2	10	10	EA

**WRITE 'N ERASE® EXPANDING FILE WITHOUT FLAP**

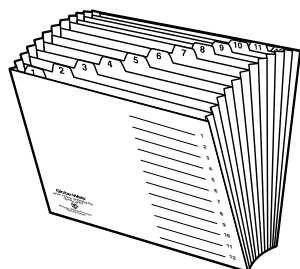

- Write on front cover index
- Erase and rewrite index with pen or pencil
- Numerically indexed colored tabs
- Mylar® reinforced gussets
- Contains 10% post-consumer recycled materials



ITEM NO.	ID NO. 78973 UPC	DESCRIPTION	CTN WT LBS	CTN CTN CUBE	CTN QTY	MIN ORD QTY	U O M
60310	60310 8	1-12, Letter Size, 13 Pockets	8.1	1.2	6	6	EA

**WRITE 'N ERASE® EXPANDING FILES WITH FLAP**

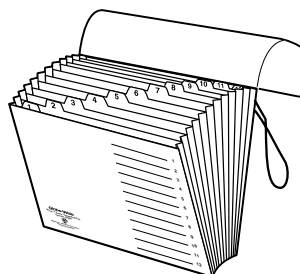

- Write on front cover index
- Erase and rewrite index with pen or pencil
- Numerically indexed colored tabs
- Elastic cord closure
- Mylar® reinforced gussets
- Flaps are blue, laminated file folder stock
- Contains 10% post-consumer recycled materials



ITEM NO.	ID NO. 78973 UPC	DESCRIPTION	CTN WT LBS	CTN CTN CUBE	CTN QTY	MIN ORD QTY	U O M
60303	60303 0	1-12, 13 Pockets	5.5	0.6	12	12	EA
<b>LETTER SIZE (10" x 12")</b>							
60309	60309 2	1-12, 13 Pockets	8.0	1.2	6	6	EA

**COLOR EXPANDING FILES WITH VELCRO® CLOSURE**

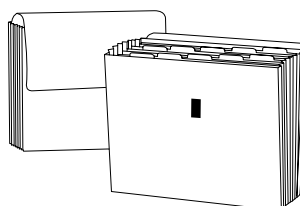

- Water resistant, laminated color covers
- Velcro® closure
- Clear insertable tabs for customization
- Flap protects contents
- Mylar® reinforced gussets
- Contains minimum 10% post-consumer materials



ITEM NO.	ID NO. 78973 UPC	DESCRIPTION	CTN WT LBS	CTN CTN CUBE	CTN QTY	MIN ORD QTY	U O M
38110	38110 5	6 Pockets, Blue	9.6	1.0	10	10	EA
38111	38111 2	6 Pockets, Red	9.6	1.0	10	10	EA
38299	38299 7	13 Pockets, Asst Colors, Blue, Red & Yellow	12.7	1.2	10	10	EA
38300	38300 0	13 Pockets, Asst Colors, Blue & Red	12.7	1.2	10	10	EA
38301	38301 7	13 Pockets, Blue	12.7	1.2	10	10	EA
38302	38302 4	13 Pockets, Red	12.7	1.2	10	10	EA
38303	38303 1	13 Pockets, Yellow	12.7	1.2	10	10	EA

## COLORED EXPANDING FILE WITH ELASTIC CORD CLOSURE

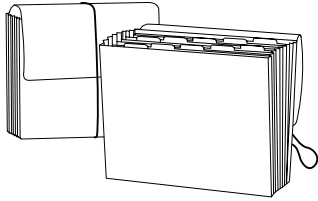

- Water resistant, laminated color covers
- Elastic cord closure
- Clear insertable tabs for customization
- Manila gussets and indexes
- Mylar® reinforced gussets
- Contains minimum 10% post-consumer recycled materials



ITEM NO.	ID NO. UPC	DESCRIPTION	CTN		MIN ORD QTY	U O M
			WT LBS	CUBE		
<b>LETTER SIZE (10" x 12")</b>						
20042	20042 0	13 Pockets, Blue	7.2	0.8	6	6 EA

## MARBLED EXPANDING FILES

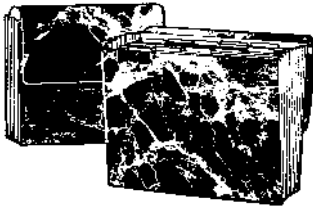

- Matte, water-resistant, laminated covers
- Clear insertable tabs for customization or pre-printed A-Z indexes
- Black gussets and indexes
- Mylar® reinforced gussets
- Velcro® closures
- Assort pack contains 4 red, 3 blue, 3 black
- Contains 10% post-consumer recycled materials



ITEM NO.	ID NO. UPC	DESCRIPTION	CTN		MIN ORD QTY	U O M
			WT LBS	CUBE		
<b>LETTER SIZE (10" x 12")</b>						
38311	38311 6	13 Pockets, Blue	12.7	1.2	10	10 EA
38312	38312 3	13 Pockets, Red	12.7	1.2	10	10 EA
38313	38313 0	13 Pockets, Black	12.7	1.2	10	10 EA
38315	38315 4	13 Pockets, Assorted Colors	12.7	1.2	10	10 EA
38351	38351 2	A-Z, Blue	17.0	1.6	10	10 EA
38353	38353 6	A-Z, Black	17.0	1.6	10	10 EA

## STUDENT FILE

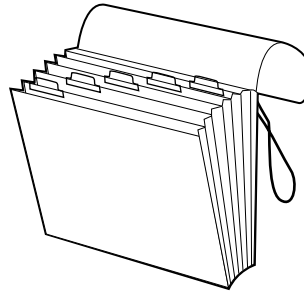

- Soil resistant Letha-Tone® cover and flap
- 6 expanding pockets
- 5 insertable clear divider tabs
- 20 printed subject titles and 10 blank inserts
- Elastic cord closure
- Contains 10% post-consumer recycled materials



ITEM NO.	ID NO. UPC	DESCRIPTION	CTN		MIN ORD QTY	U O M
			WT LBS	CUBE		
<b>LETTER SIZE (10" x 12")</b>						
MM38L	38006 1	6 Pockets	8.2	0.9	12	12 EA

## COLORED STUDENT FILE

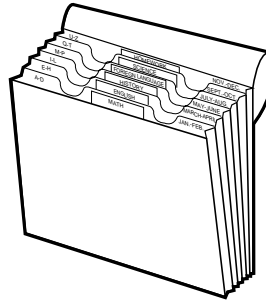

- Colored cover and flap
- Manila indexes and gussets
- Pre-printed indexes with A-Z, monthly, and subject headings
- Elastic cord closure
- Contains 10% post-consumer recycled materials



ITEM NO.	ID NO. UPC	DESCRIPTION	CTN		MIN ORD QTY	U O M
			WT LBS	CUBE		
<b>LETTER SIZE (10" x 12")</b>						
38038	38038 2	6 Pockets	7.1	0.7	12	12 EA

## ALL PURPOSE FILE

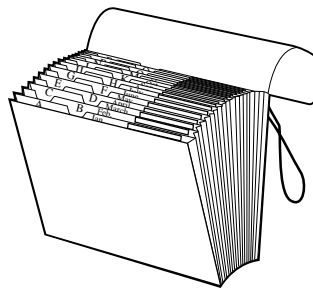

- 21 Pockets with pre-printed A-Z and monthly tabs
- Durable red rope stock
- Reinforced gussets
- Elastic cord closure
- Contains 10% post-consumer recycled materials



ITEM NO.	ID NO. UPC	DESCRIPTION	CTN		MIN ORD QTY	U O M
			WT LBS	CUBE		
<b>LETTER SIZE (10" x 12")</b>						
195	19500 9	21 Pockets	5.0	0.8	4	4 EA

**HOME FILES**

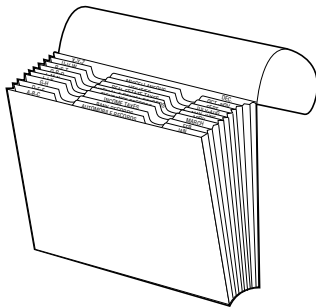

- 9 pockets
- Blue cover and flap
- Manila indexes and gussets
- Pre-printed indexes with A-Z, monthly, and home subject headings
- Contains 10% post-consumer recycled materials



ITEM NO.	ID NO. 78973 UPC	DESCRIPTION	CTN WT LBS	CTN CUBE	CTN QTY	MIN ORD QTY	U O M
<b>DRAFT SIZE (7½" x 9½")</b>							
25	25012 8	9 Pockets	9.0	0.5	12	12	EA

**HOME SECRETARY FILE**

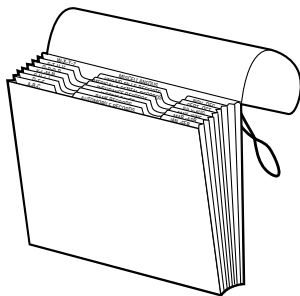

- Blue cover and flap
- Manila indexes and gussets
- Pre-printed indexes with A-Z, monthly, and home subject headings
- Elastic cord closure
- Contains 10% post-consumer recycled materials



ITEM NO.	ID NO. 78973 UPC	DESCRIPTION	CTN WT LBS	CTN CUBE	CTN QTY	MIN ORD QTY	U O M
<b>DRAFT SIZE (7½" x 9½")</b>							
MM99	99000 0	7 Pockets	6.3	0.6	12	12	EA

**HOUSEHOLD FILE**

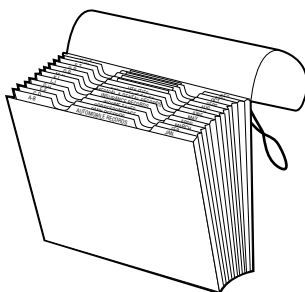

- Blue cover and flap
- Red rope indexes & gussets
- Pre-printed A-Z, monthly, household and subject indexes
- Elastic cord closure
- Contains 10% post-consumer recycled materials



ITEM NO.	ID NO. 78973 UPC	DESCRIPTION	CTN WT LBS	CTN CUBE	CTN QTY	MIN ORD QTY	U O M
<b>DRAFT SIZE (7½" x 9½")</b>							
MM73	73000 2	12 Pockets	8.2	0.6	12	12	EA

**CHECK FILE**

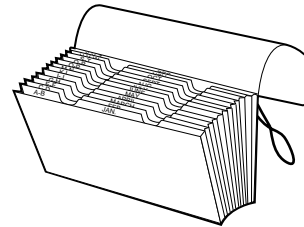

- Blue cover and flap
- Kraft indexes and gussets
- Pre-printed A-Z and monthly indexes (MM71)
- Pre-printed monthly (91)
- Elastic cord closure
- Mylar® reinforced gussets (MM71)
- Contains 10% post-consumer recycled materials



ITEM NO.	ID NO. 78973 UPC	DESCRIPTION	CTN WT LBS	CTN CUBE	CTN QTY	MIN ORD QTY	U O M
<b>CHECK SIZE (4½" x 9½")</b>							
MM71	71000 4	12 Pockets, Kraft Gussets	5.2	0.5	12	12	EA
91	91000 8	6 Pockets, Manila Gussets	2.9	0.2	12	12	EA

**CASE FILE**

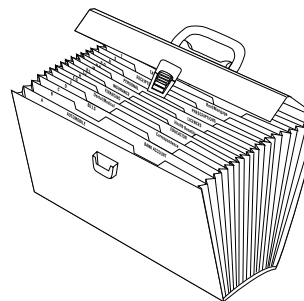

- Carrying handle
- Latch closure
- Double top red rope indexes and gussets
- Mylar® reinforced gussets
- Pre-printed subject and A-Z indexes
- Contains 10% post-consumer recycled materials



ITEM NO.	ID NO. 78973 UPC	DESCRIPTION	CTN WT LBS	CTN CUBE	CTN QTY	MIN ORD QTY	U O M
<b>LEGAL SIZE (10" x 15")</b>							
10170	10170 3	19 Pockets, Black	11.9	3.1	4	4	EA

**FILE EXPRESS™**

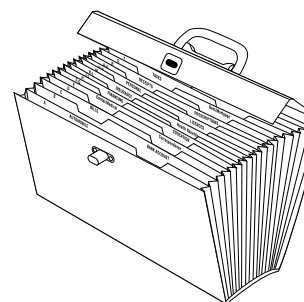

- Carrying handle
- Twist-lock closure
- Kraft indexes and gussets
- Pre-printed subject and A-Z indexes
- Mylar® reinforced gussets
- Assorted colors: 1 black, 1 blue, 1 green, 1 burgundy
- Contains 10% post-consumer recycled materials



ITEM NO.	ID NO. 78973 UPC	DESCRIPTION	CTN WT LBS	CTN CUBE	CTN QTY	MIN ORD QTY	U O M
<b>LEGAL SIZE (10" x 15")</b>							
11170	11170 2	19 Pockets, Assorted Colors	10.7	3.1	4	4	EA

## MARbled FILE EXPRESS™



- Carrying handle
- Twist-lock closure
- Black indexes and gussets
- Preprinted subject and A-Z indexes
- Mylar® reinforced gussets
- Assorted colors: 1 black, 2 blue, 1 red
- Contains 10% post-consumer recycled materials



ITEM NO.	ID NO. 78973 UPC	DESCRIPTION	CTN WT LBS	CTN CUBE	CTN QTY	MIN ORD QTY	U O M
<b>LEGAL SIZE (10" x 15")</b>							
11169	11169 6	19 Pockets, Assorted Colors	10.7	2.1	4	4	EA

## FILE EFFECTS™ FILE EXPRESS™

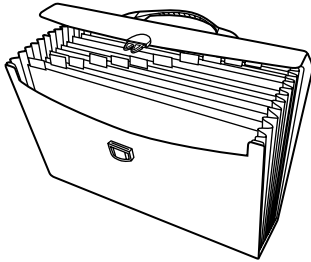

- Durable, water-resistant poly construction
- Clear tabs for customization (A-Z, monthly and blank inserts included)
- Accommodates both letter and legal size documents
- Sturdy "pop-up" carrying handle
- Secure latch closure

ITEM NO.	ID NO. 78973 UPC	DESCRIPTION	CTN WT LBS	CTN CUBE	CTN QTY	MIN ORD QTY	U O M
<b>LEGAL SIZE (11" x 15")</b>							
89075	89075 1	13 Pockets, Assorted	7.0	2.0	6	6	EA
89076	89076 8	13 Pockets, Copper	7.0	2.0	6	6	EA
89077	89077 5	13 Pockets, Slate Blue	7.0	2.0	6	6	EA
89078	89078 2	13 Pockets, Silver	7.0	2.0	6	6	EA

## POLY FILES, PORTFOLIOS, VIEWERS & FOLDERS

### FILE EFFECTS™ FILE FOLIOS

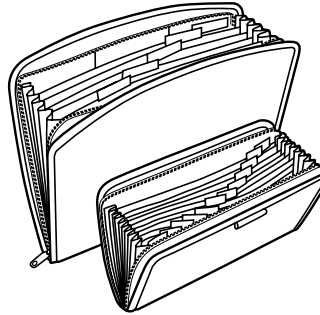

- Durable, water-resistant poly construction
- Clear tabs for customization
- Blank, A-Z and monthly inserts
- Unique zippered closure secures contents
- Media pocket for CD or diskette
- Professional sewn edge design
- Rounded bottom design for easy carry
- Assorted metallic colors: copper, slate blue and silver

ITEM NO.	ID NO. 78973 UPC	DESCRIPTION	CTN WT LBS	CTN CUBE	CTN QTY	MIN ORD QTY	U O M
<b>CHECK SIZE (6" x 11")</b>							
89096	89096 6	13 Pockets, Zipper Closure, Copper	4.0	0.3	6	6	EA
<b>LETTER SIZE (11" x 14")</b>							
89090	89090 4	7 Pockets, Zipper Closure, Asst.	9.0	1.0	6	6	EA
89091	89091 1	7 Pockets, Zipper Closure, Copper	9.0	1.0	6	6	EA
89092	89092 8	7 Pockets, Zipper Closure, Blue	9.0	1.0	6	6	EA
89093	89093 5	7 Pockets, Zipper Closure, Silver	9.0	1.0	6	6	EA
89085	89085 0	13 Pockets, Zipper Closure, Asst.	9.8	1.0	6	6	EA
89086	89086 7	13 Pockets, Zipper Closure, Copper	9.8	1.0	6	6	EA
89087	89087 4	13 Pockets, Zipper Closure, Blue	9.8	1.0	6	6	EA
89088	89088 1	13 Pockets, Zipper Closure, Silver	9.8	1.0	6	6	EA

**FILE EFFECTS™ ALL PURPOSE FILES**

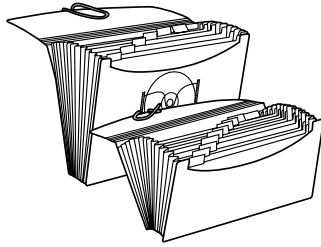

- Durable, water-resistant poly construction
- Professional black gussets
- Expanding bottom for 2 times the filing capacity of standard poly files
- Media pocket for CD or diskette
- Clear tabs for customization (blank, A-Z and monthly inserts included)
- Elastic cord closure for secure transport or storage
- Assorted metallic colors: copper, slate blue and silver

ITEM NO.	ID NO. 78973 UPC	DESCRIPTION	CTN WT LBS	CTN CUBE	CTN QTY	MIN ORD QTY	U O M
<b>CHECK SIZE (5½" x 10¼")</b>							
89043	89043 0	13 Pkts, Elastic Cord Closure, Asst.	2.3	0.3	6	6	EA
<b>LETTER SIZE (9½" x 13")</b>							
89052	89052 2	7 Pkts., Elastic Cord Closure, Silver	4.4	0.7	6	6	EA
89046	89046 1	13 Pkts, Elastic Cord Closure, Asst.	4.6	0.9	6	6	EA
89047	89047 8	13 Pkts., Elastic Cord Closure, Copper	4.6	0.9	6	6	EA
89048	89048 5	13 Pkts., Elastic Cord Closure, Blue	4.6	0.9	6	6	EA
89049	89049 2	13 Pkts., Elastic Cord Closure, Silver	4.6	0.9	6	6	EA

**FILE EFFECTS™ DESKTOP FILES**



- Durable, water-resistant poly construction
- Professional black gussets
- Expanding bottom for 2 times the filing capacity of standard poly files
- ClearVue™ window for custom content identification
- Clear tabs for customization (A-Z, monthly and blank inserts included)

ITEM NO.	ID NO. 78973 UPC	DESCRIPTION	CTN WT LBS	CTN CUBE	CTN QTY	MIN ORD QTY	U O M
<b>LETTER SIZE (9½" x 13")</b>							
89055	89055 3	13 Pockets, ClearVue Window, Asst.	3.9	0.5	6	6	EA

**GLOBALFILE® POLY EXPANDING FILES**

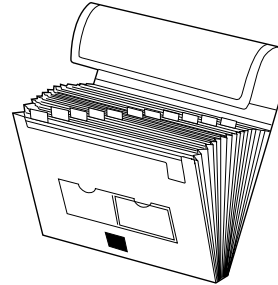

- Durable poly
- 13 pockets, 12 insertable tabs
- A-Z, monthly and blank tab inserts included
- Business card and contents card pockets
- Spine label and Velcro® closure

ITEM NO.	ID NO. 78973 UPC	DESCRIPTION	CTN WT LBS	CTN CUBE	CTN QTY	MIN ORD QTY	U O M
<b>LETTER SIZE (9½" x 13")</b>							
84130	84130 2	Black	11.6	1.2	12	12	EA
<b>LEGAL SIZE (10" x 15")</b>							
84140	84140 1	Black	14.2	1.9	12	12	EA

**POLYCOLORS™ EXPANDING FILES**

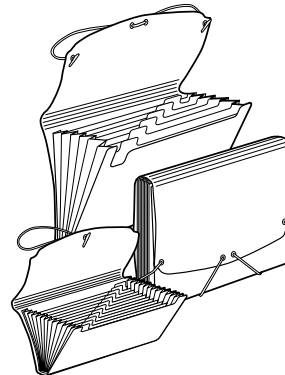

- Durable translucent polypropylene
- Double corner elastic cord closure on letter size files
- Wrap around elastic cord on check size file
- Assorted colors: blue, teal, purple, red

ITEM NO.	ID NO. 78973 UPC	DESCRIPTION	CTN WT LBS	CTN CUBE	CTN QTY	MIN ORD QTY	U O M
<b>CHECK SIZE (5½" x 10¼")</b>							
84128	84128 9	13 Pockets, Assorted Colors	5.5	0.5	12	12	EA
84164	84164 7	13 Pockets, Blue	5.5	0.5	12	12	EA
84165	84165 4	13 Pockets, Teal	5.5	0.5	12	12	EA
84166	84166 1	13 Pockets, Purple	5.5	0.5	12	12	EA
84167	84167 8	13 Pockets, Red	5.5	0.5	12	12	EA
<b>LETTER SIZE (9½" x 13")</b>							
84135	84135 7	7 Pockets, Assorted Colors	10.0	1.2	12	12	EA
84154	84154 8	7 Pockets, Blue	8.7	1.2	12	12	EA
84155	84155 5	7 Pockets, Teal	8.7	1.2	12	12	EA
84156	84156 2	7 Pockets, Purple	8.7	1.2	12	12	EA
84157	84157 9	7 Pockets, Red	8.7	1.2	12	12	EA
84136	84136 4	13 Pockets, Assorted Colors	8.7	1.2	12	12	EA
84174	84174 6	13 Pockets, Blue	10.0	1.2	12	12	EA
84175	84175 3	13 Pockets, Teal	10.0	1.2	12	12	EA
84176	84176 0	13 Pockets, Purple	10.0	1.2	12	12	EA
84177	84177 7	13 Pockets, Red	10.0	1.2	12	12	EA

## FILE N STYLE® POLY EXPANDING FILES

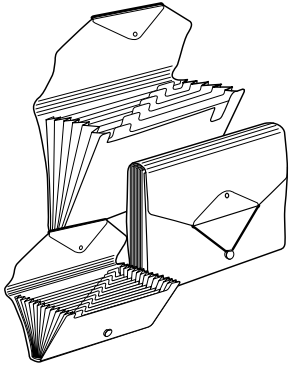

- Durable translucent waterproof poly
- Unique cord and eyelet closure
- Includes blank inserts for customization
- Assorted fashion colors: cranberry, bronze, slate and mocha

ITEM NO.	ID NO. 78973 UPC	DESCRIPTION	CTN WT LBS	CTN CUBE	CTN QTY	MIN ORD QTY	U O M
<b>COUPON SIZE (4½" x 7")</b>							
37040	37040 6	13 Pockets, Assorted Colors	2.4	0.1	6	6	EA
<b>CHECK SIZE (5½" x 10¼")</b>							
84129	84129 6	13 Pockets, Assorted Colors	2.8	0.4	6	6	EA
<b>LETTER SIZE (9½" x 13")</b>							
84137	84137 1	7 Pockets, Assorted Colors	3.9	0.7	6	6	EA
84138	84138 8	13 Pockets, Assorted Colors	4.6	0.9	6	6	EA

## GLOBLFILE® POLY DESKTOP EXPANDING FILE

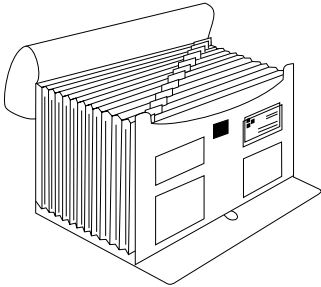

- Durable polypropylene
- Converts from portable portfolio to desktop expanding file
- Velcro® closures
- Top and bottom expansion
- 13 clear expanding pockets, 12 insertable tabs
- A-Z, monthly and blank tab inserts included
- Business card & contents card pockets
- Two 3½" diskette pockets

ITEM NO.	ID NO. 78973 UPC	DESCRIPTION	CTN WT LBS	CTN CUBE	CTN QTY	MIN ORD QTY	U O M
<b>LETTER SIZE (9½" x 13¾")</b>							
84125	84125 8	Black	6.6	0.8	6	6	EA

## GLOBALFILE® POLY EASEL EXPANDING FILE

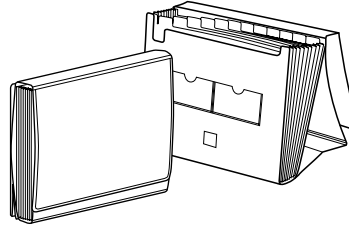

- Durable polypropylene
- Convenient easel feature
- 2 business card pockets
- 12 insertable tabs
- Velcro® closure

ITEM NO.	ID NO. 78973 UPC	DESCRIPTION	CTN WT LBS	CTN CUBE	CTN QTY	MIN ORD QTY	U O M
<b>LETTER SIZE (9½" x 13")</b>							
84139	84139 5	Black	13.8	1.4	12	12	EA

## GLOBALFILE® POLY CARRY FILES

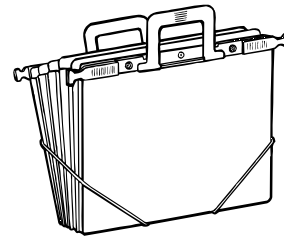

- Durable polypropylene
- Retractable handle and file hanging rods
- 12 tabbed pockets, blank labels included
- Built-in elastic cord keeps pockets closed for storage or travel

ITEM NO.	ID NO. 78973 UPC	DESCRIPTION	CTN WT LBS	CTN CUBE	CTN QTY	MIN ORD QTY	U O M
<b>LEGAL SIZE (9½" x 14¾")</b>							
84142	84142 5	12 Tabbed Pockets, Black	11.0	1.0	12	12	EA

## GLOBALFILE® POLY HANGING FILE

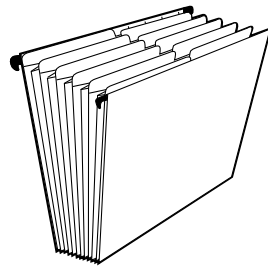

- Durable polypropylene
- Expanding hanging file
- 12 tabbed pockets
- Blank labels included

ITEM NO.	ID NO. 78973 UPC	DESCRIPTION	CTN WT LBS	CTN CUBE	CTN QTY	MIN ORD QTY	U O M
<b>LETTER SIZE (11¾" x 9½")</b>							
85030	85030 4	12 Tabbed Pockets, Black	9.4	0.6	12	12	EA

**GLOBALFILE® POLY SLIDING DISKETTE FILE**

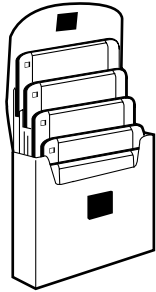

- Durable polypropylene
- 5 clear interior pockets
- Spine label
- Velcro® closure
- Assorted colors: black, blue and red

ITEM NO.	ID NO. 78973 UPC	DESCRIPTION	CTN WT LBS	CTN CUBE	CTN QTY	MIN ORD QTY	U O M
		<b>3.5" DISK SIZE (4" x 4½")</b>					
84020	84020 6	Poly Bagged	2.6	0.3	12	12	EA
84022	84022 0	Carded	2.6	0.3	12	12	EA

**GLOBALFILE® POLY PORTFOLIOS**

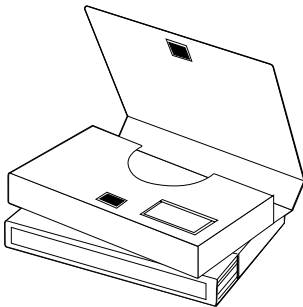

- Durable polypropylene
- Contents/business card holder
- Spine label
- Velcro® closure

ITEM NO.	ID NO. 78973 UPC	DESCRIPTION	CTN WT LBS	CTN CUBE	CTN QTY	MIN ORD QTY	U O M
		<b>LETTER SIZE (9½" x 12")</b>					
84110	84110 4	1" Capacity, Black	5.9	1.1	12	12	EA
84112	84112 8	2" Capacity, Black	6.8	2.0	12	12	EA

**POLYCOLORS™ PORTFOLIO**

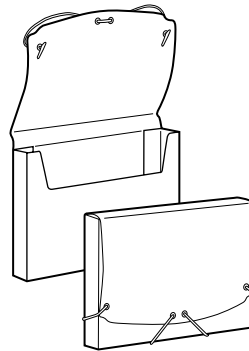

- Durable translucent polypropylene
- Double corner elastic cord closure
- Assorted colors: blue, green, purple, magenta

ITEM NO.	ID NO. 78973 UPC	DESCRIPTION	CTN WT LBS	CTN CUBE	CTN QTY	MIN ORD QTY	U O M
		<b>LETTER SIZE (9½" x 12½")</b>					
84117	84117 3	1" Capacity, Assorted Colors	5.5	1.2	12	12	EA

**FILE N STYLE® POLY PORTFOLIOS**

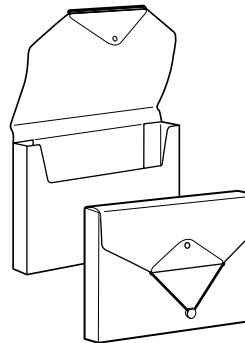

- Durable translucent waterproof poly
- Unique cord and eyelet closure
- 1" Capacity
- Assorted fashion colors: cranberry, bronze, slate and mocha

ITEM NO.	ID NO. 78973 UPC	DESCRIPTION	CTN WT LBS	CTN CUBE	CTN QTY	MIN ORD QTY	U O M
		<b>LETTER SIZE (9½" x 12")</b>					
84115	84115 9	1" Capacity, Assorted Colors	2.8	0.5	6	6	EA

## FILE EFFECTS™ ACCOUNT MANAGEMENT FOLDER

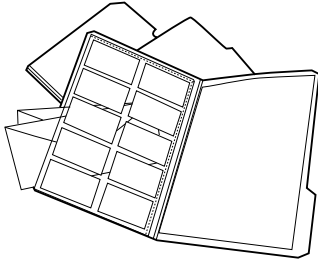

- Durable water-resistant poly construction
- 10 Business card holders
- Accessory pocket for additional storage
- Fits in file drawer
- Assorted 1/3 cut tabs

ITEM NO.	ID NO. 78973 UPC	DESCRIPTION	CTN		MIN		U
			WT LBS	CTN CUBE	CTN QTY	ORD QTY	
85053	85053 3	LETTER SIZE (9" x 12") 3/Pack, Black	6.0	0.5	24	24	PK

## FILE EFFECTS™ MASTER DOCUMENT FILE

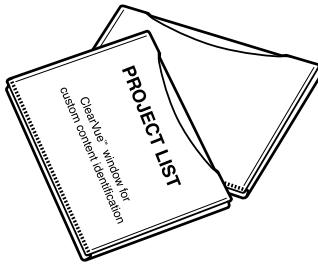

- Durable water-resistant poly construction
- 1" expanding jacket
- Unique ClearVue™ front pocket to safely store original
- Letter size
- Assorted 3 pack includes one each copper, slate blue and silver

ITEM NO.	ID NO. 78973 UPC	DESCRIPTION	CTN		MIN		U
			WT LBS	CTN CUBE	CTN QTY	ORD QTY	
89115	89115 4	LETTER SIZE (9½" x 12") 1" Expansion, Assorted 3/Pack	5.8	0.7	24	24	PK

## FILE EFFECTS™ FILE JACKETS

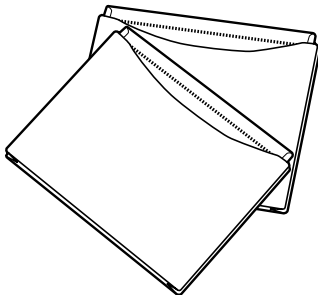

- Durable water-resistant poly construction
- Letter size with full height sides
- Full length top tab extends length of jacket
- 2" expansion
- 8½" x 11 perforated sheet of blank tab inserts
- Assorted 5 pack includes 1 copper, 2 slate blue and 2 silver

ITEM NO.	ID NO. 78973 UPC	DESCRIPTION	CTN		MIN		U
			WT LBS	CTN CUBE	CTN QTY	ORD QTY	
89020	89020 1	LETTER SIZE (9½" x 12") 2" Expansion, Assorted 5/Pack	10.7	0.7	24	24	PK

## GLOBALFILE® POLY PROJECT VIEWERS

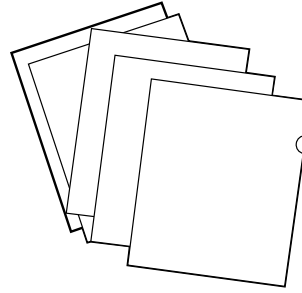

- Durable, transparent polypropylene
- For easy color-coding
- Assorted colors

ITEM NO.	ID NO. 78973 UPC	DESCRIPTION	CTN		MIN		U
			WT LBS	CTN CUBE	CTN QTY	ORD QTY	
		LETTER SIZE (9" x 11½")					
85020	85020 5	5/Pack, Assorted Colors	8.9	0.3	30	30	PK
85028	85028 1	50/Box, Assorted Colors	15.5	0.7	4	4	BX

## GLOBALFILE® POLY FOLDER VIEWERS

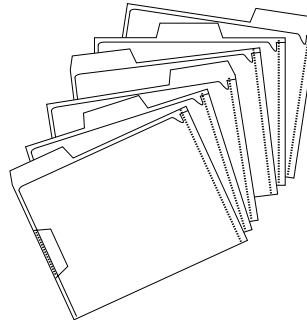

- Durable transparent polypropylene
- 1/3 cut tabs
- Security tab to hold contents in viewer
- Colors: yellow, orange, green, blue, purple, clear

ITEM NO.	ID NO. 78973 UPC	DESCRIPTION	CTN		MIN		U
			WT LBS	CTN CUBE	CTN QTY	ORD QTY	
		LETTER SIZE (9" x 11½")					
85015	85015 1	6/Pack, Assorted Colors	10.9	0.4	30	30	PK

**POLY DICTATION FOLDERS**

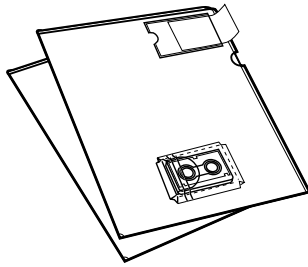

- Clear vinyl front cover
- Pocket for business card
- Pocket with protective flap for dictation cassette
- Large inside pocket for 8½x11" documents

ITEM NO.	ID NO. 78973 UPC	DESCRIPTION	CTN			MIN		U	
			WT LBS	CTN CUBE	CTN QTY	ORD QTY	O M		
<b>MINI SIZE (8½" x 11½")</b>									
2344 BEI	23440 1	Mini Size Cassette	69.8	2.0	250	25	EA		

**POLY DISKETTE VIEWERS**

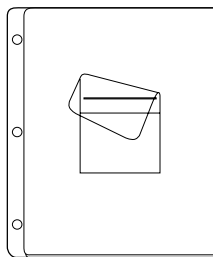

- Clear, letter size viewers combines storage for diskettes and related paper documents
- Separate pocket with flap protects diskette
- 3-hole punched for use in binders
- Anti-static vinyl

ITEM NO.	ID NO. 78973 UPC	DESCRIPTION	CTN			MIN		U	
			WT LBS	CTN CUBE	CTN QTY	ORD QTY	O M		
<b>LETTER SIZE (9½" x 11½")</b>									
85312	85312 1	3.5" Diskette Pocket, 3/Pack	6.1	0.2	12	12	PK		
85313	85313 8	3.5" Diskette Pocket, 3/Pack	16.0	0.5	30	30	PK		

**PRESSBOARD, CLASSIFICATION & POLY FOLDERS**

**PRESSBOARD EXPANDING FILE FOLDERS**

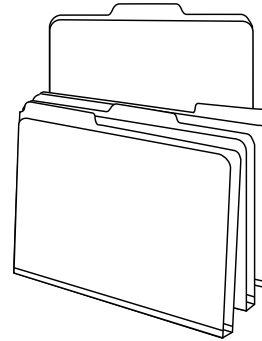

- Durable colored pressboard material
- Tyvek® tape spine
- 1" expansion
- 25 per box
- Contains 25% post-consumer recycled materials



ITEM NO.	ID NO. 78973 UPC	DESCRIPTION	CTN			MIN		U	
			WT LBS	CTN CUBE	CTN QTY	ORD QTY	O M		
<b>LETTER SIZE (9½" x 11½")</b>									
615	61500 2	Straight Cut Tabs, Green	27.2	1.4	5	5	BX		
61511	61511 8	Straight Cut Tabs, Blue	27.0	1.3	5	5	BX		
61532	61532 3	1/2 Cut Tabs, Blue	27.0	1.4	5	5	BX		
615 1/3 BLU	61514 9	1/3 Cut Tabs, Blue	27.0	1.4	5	5	BX		
61501	61501 9	Straight Cut Tabs, Gray	27.0	1.4	5	5	BX		
615 1/3 GRA	63513 0	1/3 Cut Tabs, Gray	27.0	1.3	5	5	BX		
<b>LEGAL SIZE (9½" x 14½")</b>									
616	61600 9	Straight Cut Tabs, Green	33.4	1.7	5	5	BX		
61611	61611 5	Straight Cut Tabs, Blue	33.4	1.6	5	5	BX		
616 1/3 BLU	61614 6	1/3 Cut Tabs, Blue	33.3	1.6	5	5	BX		
61601	61601 6	Straight Cut Tabs, Gray	33.3	1.6	5	5	BX		

## PRESSBOARD EXPANDING FILE FOLDERS WITH FASTENERS

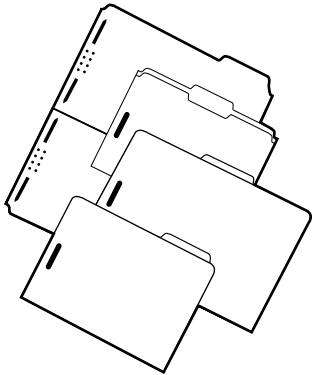

- Durable 25 pt. Type III pressboard material
- 2" Embedded fasteners in first and third positions
- Tyvek® tape spine
- 1", 2" and 3" expansion
- Assorted tab positions
- 25 per box
- Contains 25% post-consumer recycled materials



ITEM NO.	ID NO. 78973 UPC	DESCRIPTION	CTN WT LBS	CTN CUBE	CTN QTY	MIN ORD QTY	U O M
<b>LETTER SIZE (9½" x 11¾")</b>							
615F2 1/3 BLU	61516 3	1" Exp., 1/3 Cut Tabs, Blue	27.6	1.1	4	4	BX
61542	61542 2	2" Exp., 1/3 Cut Tabs, Blue	27.6	1.1	4	4	BX
61543	61543 9	3" Exp., 1/3 Cut Tabs, Blue	27.6	1.1	4	4	BX
<b>LEGAL SIZE (9½" x 14¾")</b>							
616F2 1/3 BLU	61616 0	1" Exp., 1/3 Cut Tabs, Blue	28.9	1.4	4	4	BX
61552	61552 1	2" Exp., 1/3 Cut Tabs, Blue	28.9	1.3	4	4	BX
61553	61553 8	3" Exp., 1/3 Cut Tabs, Blue	28.9	1.3	4	4	BX

## CLASSIFICATION FOLDERS

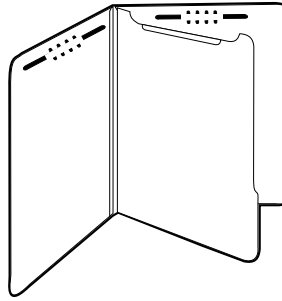

- Colored pressboard covers 25 pt. Type III pressboard
- FS – Fastener Style
  - 1" Bonded (B)
  - 2" Embedded (K)
- Kraft partitions with fasteners
- Tyvek® tape spine
- Assorted colors contain 2 dark blue, 2 bright red, 1 yellow
- Contains 20% post-consumer recycled materials



ID NO. ITEM NO.	78973 UPC	DESCRIPTION	FS	CTN WT LBS	CTN CUBE	CTN QTY	MIN ORD QTY	U O M
<b>LETTER SIZE (10" x 11¾")</b>								
<b>1 PARTITION (4-SECTIONS)</b>								
PU41 GRE	41011 9	Green	B	36.5	1.7	100	20	EA
PU541 GRE	41020 1	Green, 5/Pack	B	30.8	1.2	20	20	PK
PU41 LBL	41015 7	Lt. Blue	B	36.5	1.7	100	20	EA
PU541 LBL	41022 5	Lt. Blue, 5/Pack	B	30.8	1.2	20	20	PK
PU41 RED	41012 6	Red	B	36.5	1.4	100	20	EA
PU541 RED	41021 8	Red, 5/Pack	B	30.8	1.2	20	20	PK
98732	98732 1	Gray	B	50.2	1.4	100	100	EA
98517	98517 4	Yellow, 5/Pack	K	27.5	1.2	20	20	PK
98518	98518 1	Bright Red, 5/Pack	K	27.5	1.2	20	20	PK
98519	98519 8	Dark Blue, 5/Pack	K	27.5	1.2	20	20	PK
98515	98515 0	Assorted, 5/Pack	K	29.2	1.4	20	20	PK
<b>2 PARTITION (6-SECTIONS)</b>								
PU61 GRE	61011 3	Green	B	37.0	1.3	100	20	EA
PU561 GRE	61020 5	Green, 5/Pack	B	32.5	1.2	15	15	PK
98743	98743 7	Lt. Blue	B	52.5	1.2	100	100	EA
PU561 LBL	61022 9	Lt. Blue, 5/Pack	B	32.5	1.2	15	15	PK
PU61 RED	61012 0	Red	B	42.4	1.4	100	20	EA
PU561 RED	61021 2	Red, 5/Pack	B	32.5	1.2	15	15	PK
98744	98744 4	Gray	B	52.5	1.2	100	100	EA
98715	98715 4	Assorted, 5/Pack	K	32.5	1.3	15	15	PK
98717	98717 8	Yellow, 5/Pack	K	29.2	1.3	15	15	PK
98718	98718 5	Bright Red, 5/Pack	K	29.2	1.3	15	15	PK
98719	98719 2	Dark Blue, 5/Pack	K	29.2	1.3	15	15	PK
<b>3 PARTITION (8-SECTIONS)</b>								
98755	98755 0	Green	B	42.8	1.5	100	20	EA
98756	98756 7	Red	B	42.8	1.5	100	20	EA
<b>LEGAL SIZE (10" x 14¾")</b>								
<b>1 PARTITION (4-SECTIONS)</b>								
PU44 GRE	44011 6	Green	B	42.0	1.7	100	20	EA
PU544 GRE	44020 8	Green, 5/Pack	B	36.5	1.5	20	20	PK
PU544 LBL	44022 2	Lt. Blue, 5/Pack	B	36.5	1.5	20	20	PK
PU44 RED	44012 3	Red	B	42.0	1.7	100	20	EA
PU544 RED	44021 5	Red, 5/Pack	B	36.5	1.5	20	20	PK
98832	98832 8	Gray	B	52.5	1.6	100	100	EA
98525	98525 9	Assorted, 5/Pack	K	32.5	1.4	20	20	PK
<b>2 PARTITION (6-SECTIONS)</b>								
PU64 GRE	64011 0	Green	B	45.5	1.7	100	20	EA
PU564 GRE	64020 2	Green, 5/Pack	B	34.5	1.3	15	15	PK
PU564 LBL	64022 6	Lt. Blue, 5/Pack	B	34.5	1.5	15	15	PK
PU64 RED	64012 7	Red	B	45.7	1.7	100	20	EA
PU564 RED	64021 9	Red, 5/Pack	B	34.5	1.5	15	15	PK
98844	98844 1	Gray	B	55.5	1.6	100	100	EA
98725	98725 3	Assorted, 5/Pack	K	36.5	1.1	15	15	PK
98727	98727 7	Yellow	K	55.0	1.6	75	15	EA
98728	98728 4	Bright Red	K	55.0	1.6	75	15	EA
98729	98729 1	Dark Blue	K	55.0	1.6	75	15	EA
<b>3 PARTITION (8-SECTIONS)</b>								
98855	98855 7	Green	B	42.8	1.5	100	20	EA
98856	98856 4	Red	B	42.8	1.5	100	20	EA

**MANILA CLASSIFICATION FOLDERS**

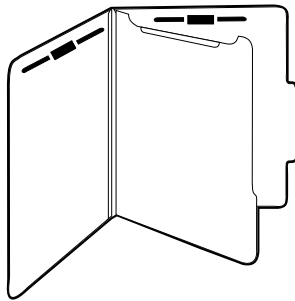

- 18 pt. manila covers and partitions
- 2" bonded fastener in 1st and 3rd position
- Single-top tab partitions with fasteners
- Tyvek® tape spine
- Contains 10% post-consumer recycled materials



ITEM NO.	ID NO. 78973 UPC	DESCRIPTION	CTN WT LBS	CTN CUBE	CTN QTY	MIN ORD QTY	U O M
<b>LETTER SIZE (10" x 11½")</b>							
98601	98601 0	1 Partition, 10/Box	28.0	0.7	10	1	BX
98602	98602 7	2 Partitions, 10/Box	28.0	0.7	10	1	BX
<b>LEGAL SIZE (10" x 14¾")</b>							
98621	98621 8	1 Partition, 10/Box	32.0	0.8	10	1	BX
98622	98622 5	2 Partitions, 10/Box	32.0	0.8	10	1	BX

**MANILA FILE DIVIDERS**

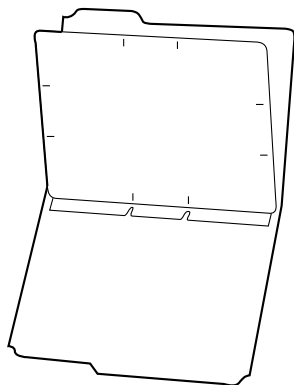

- Sturdy manila construction
- Adds two additional organizational surfaces to any file
- Contains 10% post-consumer recycled materials



ITEM NO.	ID NO. 78973 UPC	DESCRIPTION	CTN WT LBS	CTN CUBE	CTN QTY	MIN ORD QTY	U O M
<b>LETTER SIZE (8½" x 12¾")</b>							
21246	21246 1	Bottom Tab, W/Fasteners, 50/Pack	24.6	1.0	12	12	PK
<b>LEGAL SIZE (8½" x 15¾")</b>							
21248	21248 5	Bottom Tab, W/Fasteners, 50/Pack	29.6	1.2	12	12	PK

**EVERYDAY® FILE FAST SORTERS**

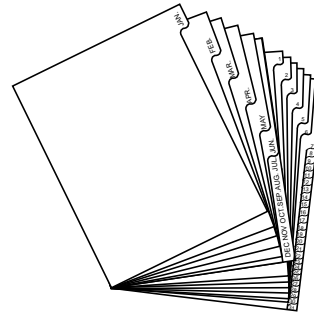

- Reinforced accordion fold and mylar tabs
- Blue polycoated or green pressboard covers
- Gray or manila pages
- Contains 10% post-consumer recycled materials



ITEM NO.	ID NO. 78973 UPC	DESCRIPTION	CTN WT LBS	CTN CUBE	CTN QTY	MIN ORD QTY	U O M
<b>A-Z, ALPHABETICAL – LETTER SIZE (10" x 11½")</b>							
1EDF	00001 3	Green/Manila, 20 Pages	11.0	0.4	10	10	EA
3EDF	00003 7	Blue/Gray, 20 Pages	10.6	0.4	10	10	EA
B3EDF	10133 8	Blue/Gray, Bulk Pack, 20 Pages	10.5	0.4	10	10	EA
<b>A-Z/1-20 COMBINED – LEGAL SIZE (10" x 14¾")</b>							
7EDF	00007 5	Blue/Gray, 20 Pages	13.7	0.7	10	10	EA
<b>1-31, DAILY – LETTER SIZE (10" x 11½")</b>							
4EDF	00004 4	Blue/Gray, 30 Pages	15.1	0.6	10	10	EA
B4EDF	10143 7	Blue/Gray, Bulk Pack, 30 Pages	15.1	0.6	10	10	EA
<b>JAN-DEC/1-31, COMBINED – LETTER SIZE (10" x 11½")</b>							
5EDF	00005 1	Blue/Gray, 42 Pages	12.0	0.7	10	10	EA

**WRITE 'N ERASE® EVERYDAY® FILE**

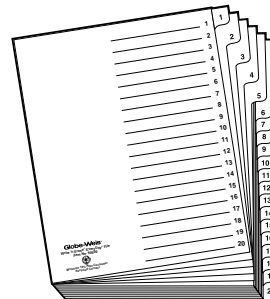

- Write on front cover index
- Erase and rewrite index with pen or pencil
- Numerically indexed colored tabs
- Contains 10% post-consumer recycled materials



ITEM NO.	ID NO. 78973 UPC	DESCRIPTION	CTN WT LBS	CTN CUBE	CTN QTY	MIN ORD QTY	U O M
<b>LETTER SIZE (10" x 11½")</b>							
60300	60300 9	1-20, 20 Pages	10.3	0.4	10	10	EA

## FIBERBOARD STORAGE

### FIBERBOARD INDEX CARD STORAGE BOXES

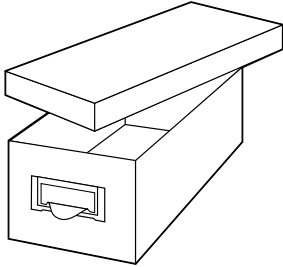

- Heavy-duty fiberboard
- Portable records storage units
- With adjustable follower assembly that holds materials upright
- Label holder with a pull and blank inserts
- Holds 1,000 cards
- Contains 70% minimum post-consumer recycled materials



ITEM NO.	ID NO. 78973 UPC	DESCRIPTION	CTN WT LBS	CTN CUBE	CTN QTY	MIN ORD QTY	U O M
<b>3" X 5" CARD SIZE (4" x 5 1/2" x 11 1/2")</b>							
93 BLA	00931 3	Black, Agate	11.1	2.1	12	12	EA
93 GRE	00932 0	Green, Agate	11.1	2.1	12	12	EA
93 WA	00933 7	Walnut	11.1	2.1	12	12	EA
<b>4" X 6" CARD SIZE (5" x 6 1/2" x 11 1/2")</b>							
94 BLA	00941 2	Black, Agate	14.0	3.2	12	12	EA
94 GRE	00942 9	Green, Agate	14.0	3.2	12	12	EA
94 WA	00943 6	Walnut	14.0	3.2	12	12	EA
<b>5" X 8" CARD SIZE (6" x 8 1/2" x 11 1/2")</b>							
95 BLA	00951 1	Black, Agate	8.9	2.5	6	6	EA
95 GRE	00952 8	Green, Agate	8.9	2.5	6	6	EA
95 WA	00953 5	Walnut	8.9	2.5	6	6	EA
<b>4 1/2" x 9" CHECK SIZE (5" x 9 1/2" x 11 1/2")</b>							
99 GRE	00992 4	Green, Agate Tray	8.9	2.3	6	6	EA
<b>6" X 9" CARD SIZE (7" x 9 1/2" x 11 1/2")</b>							
96 GRE	00962 7	Green, Agate	11.8	3.2	6	6	EA

### HEAVY DUTY STORAGE BOXES WITH LIDS

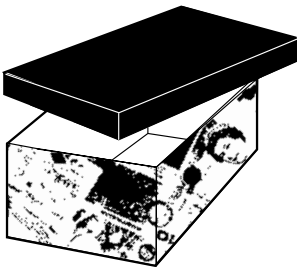

- Durable fiberboard construction
- Assort Pack includes 3 with Foreign Currency wrap and 3 with Green Marble wrap
- Self-adhesive label holder and label included
- Contains 70% minimum post-consumer recycled materials



ITEM NO.	ID NO. 78973 UPC	DESCRIPTION	CTN WT LBS	CTN CUBE	CTN QTY	MIN ORD QTY	U O M
<b>BOX SIZE (5" x 9 1/2" x 11 1/2")</b>							
00996	00996 2	Assorted Pack	8.9	2.3	6	6	EA

### INDEX CARD STORAGE CASES

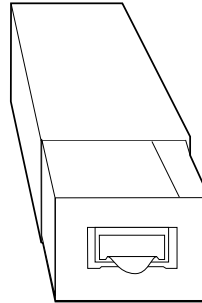

- Heavy-duty fiberboard
- 14 1/2" filing capacity for 1,300 cards plus file guides
- Combination label holder and drawer pull
- Available with or without follower assembly
- Contains 70% minimum post-consumer recycled materials



ITEM NO.	ID NO. 78973 UPC	DESCRIPTION	CTN WT LBS	CTN CUBE	CTN QTY	MIN ORD QTY	U O M
<b>3" X 5" CARD SIZE (4 1/2" x 5 1/2" x 15")</b>							
35C GRE	00035 8	Green	15.9	3.0	12	12	EA
35FB GRE	00235 2	Green, W/Follower Block	18.7	3.0	12	12	EA
<b>4" X 6" CARD SIZE (5 1/2" x 6 1/2" x 15")</b>							
46C GRE	00046 4	Green	20.8	4.4	12	12	EA
46FB GRE	00246 8	Green, W/Follower Block	22.3	4.3	12	12	EA
<b>5" X 8" CARD SIZE (5 1/2" x 8 1/2" x 15")</b>							
58C GRE	00058 7	Green	13.6	3.3	6	6	EA
58FB GRE	00258 1	Green, W/Follower Block	15.8	3.3	6	6	EA
<b>6" X 9" CARD SIZE (7 1/2" x 9 1/2" x 15")</b>							
69C GRE	00069 3	Green	16.2	4.3	6	6	EA
69FB GRE	00269 7	Green, W/Follower Block	17.4	4.3	6	6	EA

### HEAVY DUTY STORAGE DRAWERS

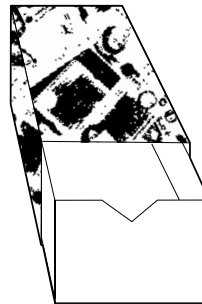

- Durable fiberboard construction
- Pull-out drawer for easy access to contents
- Assort Pack includes 3 with Foreign Currency wrap and 3 with Green Marble wrap
- Self-adhesive label holder and label included
- Contains 70% minimum post-consumer recycled materials



ITEM NO.	ID NO. 78973 UPC	DESCRIPTION	CTN WT LBS	CTN CUBE	CTN QTY	MIN ORD QTY	U O M
<b>BOX SIZE (5 1/2" x 6 1/2" x 15")</b>							
00248	00248 2	Assorted Pack	8.9	1.7	6	6	EA

**BOX FILES**

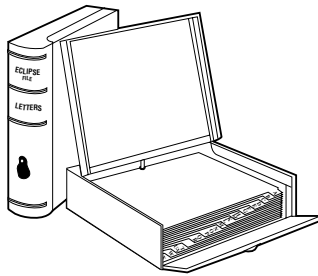

- Durable fiberboard construction
- Curved spine with pull tab for bookshelf storage
- Suitcase-style latch for security
- 16 A-Z indexes
- Contains 70% minimum post-consumer recycled materials



ITEM NO.	ID NO. 78973 UPC	DESCRIPTION	CTN		MIN		U	
			WT LBS	CTN CUBE	CTN QTY	ORD QTY	O	M
22SL GRE	00226 0	Green	14.4	2.8	6	6	EA	
LETTER SIZE, DOUBLE THICK (4 <sup>5</sup> / <sub>8</sub> " x 10 <sup>13</sup> / <sub>16</sub> " x 11 <sup>5</sup> / <sub>8</sub> ")								
LETTER SIZE (2 <sup>5</sup> / <sub>8</sub> " x 10 <sup>13</sup> / <sub>16</sub> " x 11 <sup>5</sup> / <sub>8</sub> ")								
8SLAZ GRE	00086 0	Green	23.6	3.3	12	12	EA	

**DOCUMENT STORAGE CASE**

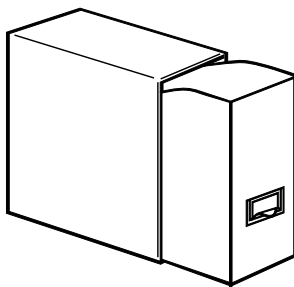

- Durable fiberboard sleeve and drawer
- Combination label holder and drawer pull
- Contains 70% minimum post-consumer recycled materials



ITEM NO.	ID NO. 78973 UPC	DESCRIPTION	CTN		MIN		U	
			WT LBS	CTN CUBE	CTN QTY	ORD QTY	O	M
102 GRE	10205 2	Green	13.1	2.8	6	6	EA	
LETTER SIZE (10 <sup>7</sup> / <sub>16</sub> " x 4 <sup>3</sup> / <sub>4</sub> " x 11 <sup>7</sup> / <sub>8</sub> ")								

**TRANSFER CASES**

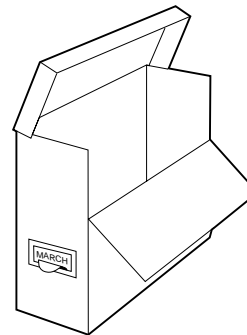

- Storage for vertical files, brochures, and magazines
- Hinged lid and drop front for easy access
- Label holder doubles as pull
- Contains 70% minimum post-consumer recycled materials



ITEM NO.	ID NO. 78973 UPC	DESCRIPTION	CTN		MIN		U	
			WT LBS	CTN CUBE	CTN QTY	ORD QTY	O	M
591 GRE	00591 9	Green	8.7	2.7	6	6	EA	
LETTER SIZE (10 <sup>1</sup> / <sub>2</sub> " x 12 <sup>1</sup> / <sub>2</sub> " x 4 <sup>1</sup> / <sub>4</sub> ")								
592 GRE	00592 6	Green	10.0	3.3	6	6	EA	
LEGAL SIZE (10 <sup>1</sup> / <sub>2</sub> " x 15 <sup>1</sup> / <sub>4</sub> " x 4 <sup>1</sup> / <sub>4</sub> ")								

**COLUMBIA® BINDING CASES**

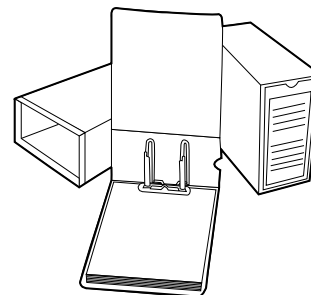

- Heavy fiberboard exterior
- Durable kraft binders with thumb cut pull
- 2<sup>1</sup>/<sub>2</sub>" regular or 3<sup>1</sup>/<sub>8</sub>" high arch filing capacity
- 2<sup>1</sup>/<sub>2</sub>" center-to-center binding posts
- Contains 35% minimum post-consumer recycled materials



ITEM NO.	ID NO. 78973 UPC	DESCRIPTION	CTN		MIN		U	
			WT LBS	CTN CUBE	CTN QTY	ORD QTY	O	M
B49BC	09149 3	Regular Arch	10.5	1.7	12	12	EA	
NOTE SIZE (7 <sup>1</sup> / <sub>2</sub> " x 3 <sup>3</sup> / <sub>8</sub> " x 12 <sup>1</sup> / <sub>2</sub> ")								
50BC	01150 7	Regular Arch, Bulk Packed	37.2	4.2	36	36	EA	
B50BC	09250 6	Regular Arch	12.2	2.2	12	12	EA	
LETTER SIZE (9 <sup>1</sup> / <sub>2</sub> " x 4 <sup>1</sup> / <sub>8</sub> " x 12 <sup>1</sup> / <sub>2</sub> ")								
50H	01050 0	High Arch, Bulk Packed	37.1	4.9	36	36	EA	
B50H	09150 9	High Arch	12.6	2.3	12	12	EA	
LEGAL SIZE (9 <sup>1</sup> / <sub>2</sub> " x 3 <sup>1</sup> / <sub>4</sub> " x 15 <sup>1</sup> / <sub>4</sub> ")								
B51BC	09251 3	Regular Arch	13.3	2.5	12	12	EA	
LEGAL SIZE (9 <sup>1</sup> / <sub>2</sub> " x 4 <sup>1</sup> / <sub>8</sub> " x 15 <sup>1</sup> / <sub>4</sub> ")								
51H	01051 7	High Arch, Bulk Packed	43.1	5.3	36	36	EA	
B51H	09151 6	High Arch	13.9	2.8	12	12	EA	

## GUIDES

### MANILA CARD INDEX GUIDES WITH BLANK TABS

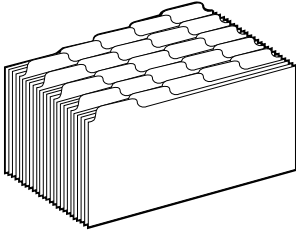

- 15-point manila stock
- Blank tabs for customization
- Contains 10% post-consumer recycled materials



ITEM NO.	ID NO. 78973 UPC	DESCRIPTION	CTN WT LBS	CTN CUBE	CTN QTY	MIN ORD QTY	U O M
<b>3" x 5" CARD SIZE</b>							
3005 1/3	30053 3	1/3 Cut Tabs, 100/Pack	18.7	0.6	25	1	PK
3005 1/5	30055 7	1/5 Cut Tabs, 100/Pack	18.7	0.6	25	1	PK
<b>4" x 6" CARD SIZE</b>							
4006 1/3	40063 9	1/3 Cut Tabs, 100/Pack	17.9	0.5	15	1	PK
4006 1/5	40065 3	1/5 Cut Tabs, 100/Pack	17.8	0.5	15	1	PK
<b>5" x 8" CARD SIZE</b>							
5008 1/3	50083 4	1/3 Cut Tabs, 100/Pack	20.6	0.5	10	1	PK
5008 1/5	50085 8	1/5 Cut Tabs, 100/Pack	20.6	0.61	10	1	PK

### MANILA CARD INDEX GUIDES

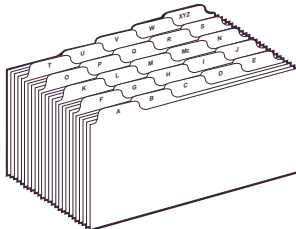

- 15-point manila stock
- 1/5 cut tabs
- A-Z pre-printed indexes
- Contains 10% post-consumer recycled materials



ITEM NO.	ID NO. 78973 UPC	DESCRIPTION	CTN WT LBS	CTN CUBE	CTN QTY	MIN ORD QTY	U O M
<b>3" x 5" CARD SIZE</b>							
3255	03255 7	A-Z Pre-printed Tabs, 25 Cards/Set	18.4	0.6	100	10	ST
<b>4" x 6" CARD SIZE</b>							
4256	04256 3	A-Z Pre-printed Tabs, 25 Cards/Set	15.0	0.4	50	10	ST
<b>5" x 8" CARD SIZE</b>							
5258	05258 6	A-Z Pre-printed Tabs, 25 Cards/Set	48.6	1.2	100	10	ST

### MANILA VERTICAL GUIDES WITH ALPHABETICAL TABS

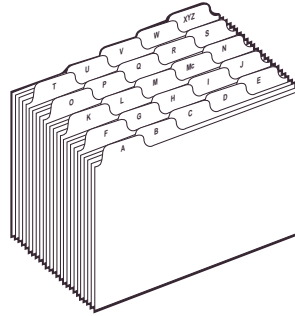

- 18-point manila stock
- 1/5 cut tabs
- Alphabetical pre-printed indexes
- Contains 10% post-consumer recycled materials



ITEM NO.	ID NO. 78973 UPC	DESCRIPTION	CTN WT LBS	CTN CUBE	CTN QTY	MIN ORD QTY	U O M
<b>LETTER SIZE (10" x 11 1/2")</b>							
9521	95210 7	A-Z Pre-printed Tabs, 25/Set	16.5	0.4	10	10	ST
<b>LEGAL SIZE (10" x 14 1/4")</b>							
9524	95240 4	A-Z Pre-printed Tabs, 25/Set	20.0	0.6	10	10	ST

### PRESSBOARD VERTICAL GUIDES

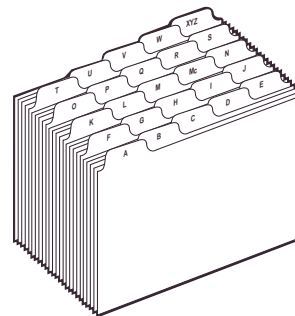

- Durable 25-point pressboard
- 1/3 or 1/5 cut tabs
- Pre-printed indexes
- Contains 25% post-consumer recycled materials



ITEM NO.	ID NO. 78973 UPC	DESCRIPTION	CTN WT LBS	CTN CUBE	CTN QTY	MIN ORD QTY	U O M
<b>LETTER SIZE (10" x 11 1/2")</b>							
31PX91	31911 5	1-31 Pre-printed Tabs	29.7	0.7	10	1	ST
95PX2125	91245 3	A-Z Pre-printed Tabs, 25 /Set	24.7	0.6	10	1	ST
<b>LEGAL SIZE (10" x 14 1/4")</b>							
95PX2425	94245 0	A-Z Pre-printed Tabs, 25 /Set	31.4	0.7	10	1	ST

**PRESSBOARD VERTICAL GUIDES WITH METAL TABS**

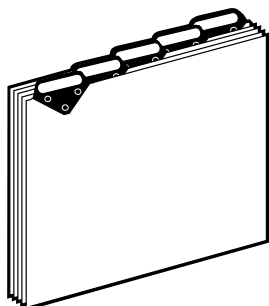

- Durable 25-point pressboard
- 1/5 cut tabs
- Metal tabs with blank or pre-printed insertable indexes
- Contains 25% post-consumer recycled materials



ITEM NO.	ID NO. 78973 UPC	DESCRIPTION	CTN WT LBS	CTN CUBE	CTN QTY	MIN ORD QTY	U O M
<b>LETTER SIZE (10" x 11¼")</b>							
95MX21	91521 8	25 guides/Set, A-Z Pre-printed Tab	32.5	1.0	10	1	ST
<b>LEGAL SIZE (10" x 14¼")</b>							
95MX24	94521 5	25 Guides/Set, A-Z Pre-printed Tab	39.8	0.9	10	1	ST

**MANILA OUT GUIDES**

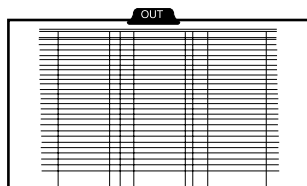

- Durable 18-point manila construction
- 1/5 cut, red, center tabs
- Tabs are pre-printed "OUT"
- Contains 10% post-consumer recycled materials



ITEM NO.	ID NO. 78973 UPC	DESCRIPTION	CTN WT LBS	CTN CUBE	CTN QTY	MIN ORD QTY	U O M
<b>LETTER SIZE (10" x 11¼")</b>							
90OUT1	90100 6	25 Guides/Set	15.4	0.4	10	1	BX
<b>LEGAL SIZE (10" x 14¼")</b>							
90OUT4	90400 7	25 Guides/Set	19.8	0.6	10	1	BX

