

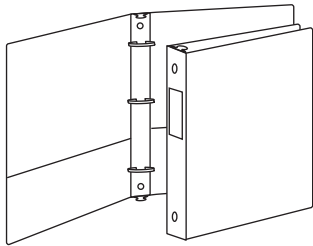

table of **contents**



binder facts	39
presentation binders	40-46
reference & storage binders	47-53
specialty purpose binders	54
school binders	55
poly binders	56-57
binder indexes & pockets	57-59
binder accessories	60
presentation books & report covers	60-63
HOLDit!® labeling & presentation accessories	63-64
merchandise displays	65



Reference & Storage Binders



Versatile binders for record keeping, reference materials and general office use.



	ECONOMY NON-LOCKING	STANDARD LOCKING	MOLDED LOCKING	NON-STICK/ TRANSFER SAFE LOCKING	PREMIUM LOCKING
	EconomyValue™	Prestige	EasyOpen® Profile™	*XtraLife®	EasyOpen®
	Basic Value®				Performer™
	XtraValue™	XtraValue™	EasyOpen® Profile™		EasyOpen®
		Prestige	EasyOpen® †SuperLife™		Slant-D®

*1 Year warranty against hinge and seam splitting. Cold crack tested to -50°F.
†Lifetime guarantee on cover.

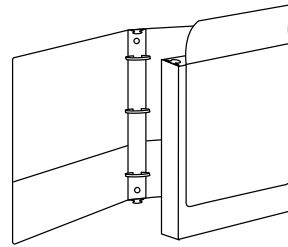
Presentation Binders



Innovative solutions for professional presentations through our wide range of presentation binders.

	ECONOMY NON-LOCKING	STANDARD LOCKING	NON-STICK/ TRANSFER SAFE LOCKING	CONCEALED LOCKING	PREMIUM LOCKING
	Economy Value™	Premium ClearVue™		Presenter ClearVue™	EasyOpen®
	Basic Value®			SpineVue®	
	XtraValue™	XtraValue™	*XtraLife®		EasyOpen®
		SpineVue®			Slant-D®

*1 Year warranty against hinge and seam splitting. Cold crack tested to -50°F.

Binder Sheet Capacity

Select the right size binder for the task. Shown are the approximate number of sheets binders will hold, including index.

SLANT-D® RING SHEET CAPACITY		
SIZE	LOCKING	NON-LOCKING
5"	1100	1050
4"	890	835
3"	725	725
2"	540	540
1½"	375	375
1"	270	240

ROUNDING SHEET CAPACITY		
SIZE	LOCKING	NON-LOCKING
3"	625	625
2"	450	475
1½"	375	350
1"	250	225
5/8"	--	125

Measurements based on use of 20 lb. paper.

SpineVue® Binders

SpineVue® binders are premium insertable binders in both looks and function. The SpineVue® wrap-around clear overlay allows user to insert a single, standard letter size sheet (8½" x 11"). Create custom binders in less than 1/3 the time! Available in Slant-D® Locking or SureLock™ Locking Round Ring.

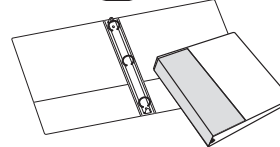
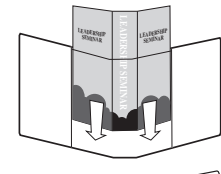
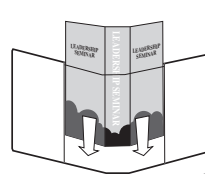

SureLock™ Locking Round Ring Binder, page 43.

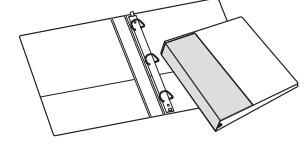

Slant-D® Locking Ring Binder, page 40.

FREE Software Templates

Visit our website at www.cardinalbrands.com/support for free software templates on our OneStep® family of indexes, Ezy Index® Dividers, Showfile™ family of display books, HOLDit!® Label Holders, EasyOpen® Profile and WorkPlace™ Spine Labels, SpineVue® binders, ClearThru™ binders, EasyOpen® ClearVue™ binders, XtraLife® ClearVue™ binders, and Premium Slant-D® ClearVue™ binders.



D-RING PRESENTATION BINDERS

SPINEVUE® LOCKING SLANT-D® RING BINDERS

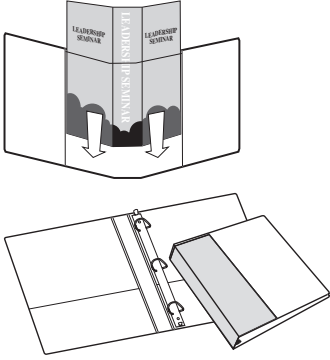

- Exclusive wrap around clear overlay holds standard 8½"x11" sheets
- Easy to customize for presentation or filing -- no trimming or fumbling with small spine inserts or separate cover inserts as needed for standard overlay binders
- FREE software templates from www.cardinalbrands.com/support
- Slant-D® locking ring metal with GelTab™ triggers are uniquely angled to allow smoother movement of sheets and holds up to 25%-50% more than conventional round ring metals
- Leather-like vinyl cover material adds professional, premium look not found on standard overlay binders
- Horizontal pockets inside front and back covers
- Poly sheet lifter included
- XtraLife® Hinge design for maximum strength
- Recycled Content: 45% by material weight



U.S. Patent #5,720,564



LOCKING

ITEM NO.	ID NO. 83086 UPC	COLOR	CTN WT LBS	CTN CUBE	CTN QTY	MIN ORD QTY	U O M
18101	18101 6	Black	15.3	1.0	12	12	EA
18102	18102 3	Navy	15.3	1.0	12	12	EA
18103	18103 0	White	15.3	1.0	12	12	EA
18108	18108 5	Maroon	15.3	1.0	12	12	EA
1½" CAPACITY, 8½" X 11" SHEET SIZE (W X H)							
18111	18111 5	Black	16.2	1.3	12	12	EA
18112	18112 2	Navy	16.2	1.3	12	12	EA
18113	18113 9	White	16.2	1.3	12	12	EA
18118	18118 4	Maroon	16.2	1.3	12	12	EA
2" CAPACITY, 8½" X 11" SHEET SIZE (W X H)							
18121	18121 4	Black	20.3	1.9	12	12	EA
18122	18122 1	Navy	20.3	1.9	12	12	EA
18123	18123 8	White	20.3	1.9	12	12	EA
18128	18128 3	Maroon	20.3	1.9	12	12	EA

D-RING PRESENTATION BINDERS (Heavy-duty, Active Use)

SLANT-D® LOCKING CLEARVUE™ BINDERS

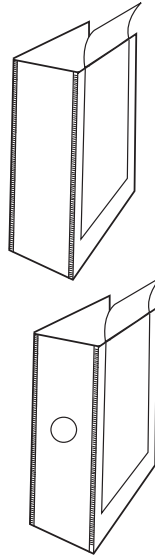

- Clear overlays on front, back and spine allow insertion of custom title sheets
- Slant-D® locking ring secures binder contents and keeps ring wires aligned
- Holds 25%-50% more than conventional round ring binders
- Patented Expand-A-Pocket® in back expands to hold up to ½" stack of materials
- Exclusive patented DataGuard™ Pocket inside front prevents document damage
- Made with strongest, heaviest virgin vinyl in industry
- Stands up to years of use with XtraLife® Hinge and BlindEdge™ Weld
- Flat poly sheet lifter
- Recycled Content: 44% by material weight
- Finger hole in 5" capacity for easy shelf removal
- FREE software templates from www.cardinalbrands.com/support



LOCKING

ITEM NO.	ID NO. 83086 UPC	COLOR	CTN WT LBS	CTN CUBE	CTN QTY	MIN ORD QTY	U O M
10200	10200 4	White	17.7	1.0	12	12	EA
10201	10201 1	Black	17.7	1.0	12	12	EA
10242	10242 4	Blue	17.7	1.0	12	12	EA
1½" CAPACITY, 8½" X 11" SHEET SIZE (W X H)							
10400	10400 8	White	20.6	1.3	12	12	EA
10401	10401 5	Black	20.6	1.3	12	12	EA
10442	10442 8	Blue	20.6	1.3	12	12	EA
2" CAPACITY, 8½" X 11" SHEET SIZE (W X H)							
10500	10500 5	White	25.8	1.9	12	12	EA
10501	10501 2	Black	25.8	1.9	12	12	EA
10542	10542 5	Blue	25.8	1.9	12	12	EA
3" CAPACITY, 8½" X 11" SHEET SIZE (W X H)							
10600	10600 2	White	15.3	1.9	6	6	EA
10601	10601 9	Black	15.3	1.9	6	6	EA
10642	10642 2	Blue	15.3	1.9	6	6	EA
4" CAPACITY, 8½" X 11" SHEET SIZE (W X H)							
10800	10800 6	White	16.4	2.3	6	6	EA
10801	10801 3	Black	16.4	2.3	6	6	EA
5" CAPACITY, 8½" X 11" SHEET SIZE (W X H)							
10900	10900 3	White	7.2	0.8	2	2	EA
10901	10901 0	Black	7.2	0.8	2	2	EA

D-RING PRESENTATION BINDERS (Heavy-duty, Active Use)

EASYOPEN® CLEARVUE™ LOCKING D-RING BINDERS

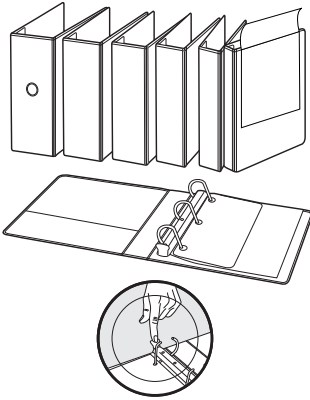

- Opens and closes with just the touch of one finger
- "Ease-of-Use" Commendation from Arthritis Foundation
- Safer and easier to use than any other ring metal
- No more pinched fingers
- Lock engages instantly when closed, eliminating the two-step and two-handed operation
- No scratched desks or bookshelves from triggers that don't close up
- Clear overlay on front, back and spine allows insertion of custom title sheets
- Holds 25% more than conventional round ring binders
- Horizontal pockets inside front and back covers
- Flat poly sheet lifter included
- Recycled content: 44% by material weight
- FREE software templates from www.cardinalbrands.com/support



ITEM NO.	ID NO. 83086 UPC	COLOR	CTN WT LBS	CTN CUBE	CTN QTY	MIN ORD QTY	U O M
1" CAPACITY, 8½" X 11" SHEET SIZE (W X H)							
10300	10300 1	White	14.0	1.0	12	12	EA
10301	10301 8	Black	14.0	1.0	12	12	EA
1½" CAPACITY, 8½" X 11" SHEET SIZE (W X H)							
10310	10310 0	White	16.0	1.3	12	12	EA
10311	10311 7	Black	16.0	1.3	12	12	EA
2" CAPACITY, 8½" X 11" SHEET SIZE (W X H)							
10320	10320 9	White	19.4	1.8	12	12	EA
10321	10321 6	Black	19.4	1.8	12	12	EA
3" CAPACITY, 8½" X 11" SHEET SIZE (W X H)							
10330	10330 8	White	12.4	1.9	6	6	EA
10331	10331 5	Black	12.4	1.9	6	6	EA
4" CAPACITY, 8½" X 11" SHEET SIZE (W X H)							
10340	10340 7	White	15.0	1.9	6	6	EA
10341	10341 4	Black	15.0	1.9	6	6	EA
5" CAPACITY, 8½" X 11" SHEET SIZE (W X H)							
10350	10350 6	White	6.0	0.8	2	2	EA
10351	10351 3	Black	6.0	0.8	2	2	EA

XTRALIFE® CLEARVUE™ NON-STICK LOCKING D-RING BINDERS

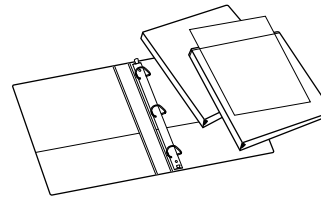

- Cover material will not stick to any printed pages, damage photos or prints
- XtraLife® material is stronger, **binders are guaranteed for 1 full year against splitting along seams or hinge**
- Cold crack tested to -50°F
- Slant-D® locking rings with GelTab™ triggers hold more, stay aligned, won't accidentally open and spill
- Horizontal pockets inside front and back
- Recycled content: 50% by material weight
- FREE software templates from www.cardinalbrands.com/support



ITEM NO.	ID NO. 83086 UPC	COLOR	CTN WT LBS	CTN CUBE	CTN QTY	MIN ORD QTY	U O M
1" CAPACITY, 8½" X 11" SHEET SIZE (W X H)							
26300	26300 2	White	15.3	1.0	12	12	EA
26301	26301 9	Black	15.3	1.0	12	12	EA
26302	26302 6	Blue	15.3	1.0	12	12	EA
26300M	26300 2	White PDQ	7.0	0.6	6	6	EA
1½" CAPACITY, 8½" X 11" SHEET SIZE (W X H)							
26310	26310 1	White	18.6	1.3	12	12	EA
26311	26311 8	Black	18.6	1.3	12	12	EA
26312	26312 5	Blue	18.6	1.3	12	12	EA
26310M	26310 1	White PDQ	15.0	1.3	12	12	EA
26311M	26311 8	Black PDQ	15.0	1.3	12	12	EA
2" CAPACITY, 8½" X 11" SHEET SIZE (W X H)							
26320	26320 0	White	21.3	1.8	12	12	EA
26321	26321 7	Black	21.3	1.8	12	12	EA
26322	26322 4	Blue	21.3	1.8	12	12	EA
26326	26326 2	White PDQ	10.0	1.0	6	6	EA
3" CAPACITY, 8½" X 11" SHEET SIZE (W X H)							
26330	26330 9	White	13.8	1.9	6	6	EA
26331	26331 6	Black	13.8	1.9	6	6	EA
26332	26332 3	Blue	13.8	1.9	6	6	EA
4" CAPACITY, 8½" X 11" SHEET SIZE (W X H)							
26340	26340 8	White	13.0	1.9	6	6	EA
26341	26341 5	Black	13.0	1.9	6	6	EA
26342	26342 2	Blue	13.0	1.9	6	6	EA
5" CAPACITY, 8½" X 11" SHEET SIZE (W X H)							
26350	26350 7	White	5.7	0.8	2	2	EA
26351	26351 4	Black	5.7	0.8	2	2	EA
26352	26352 1	Blue	5.7	0.8	2	2	EA



D-RING PRESENTATION BINDERS

XTRAVUE™ CLEARVUE™ LOCKING D-RING BINDERS

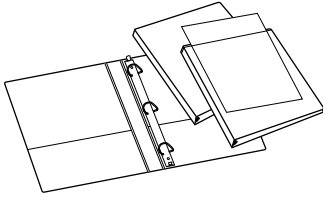

- Clear overlays on front, back and spine allows insertion of custom title sheets
- Horizontal pockets inside front and back
- XtraLife® hinge provides added strength
- Slant-D® locking rings with GelTab™ triggers hold more, stay aligned, won't accidentally open and spill
- MicroFine™ suede finish vinyl cover
- Sheet size 8½" X 11"
- 45% Recycled Content



ITEM NO.	ID NO. 83086 UPC	COLOR	CTN WT LBS	CTN CUBE	CTN QTY	MIN ORD QTY	U O M
1" CAPACITY, 8½" X 11" SHEET SIZE (W X H)							
19010	19010 0	White	14.1	1.0	12	12	EA
19011	19011 7	Black	14.1	1.0	12	12	EA
1½" CAPACITY, 8½" X 11" SHEET SIZE (W X H)							
19020	19020 9	White	16.8	1.3	12	12	EA
19021	19021 6	Black	16.8	1.3	12	12	EA
2" CAPACITY, 8½" X 11" SHEET SIZE (W X H)							
19030	19030 8	White	20.3	1.9	12	12	EA
19031	19031 5	Black	20.3	1.9	12	12	EA
3" CAPACITY, 8½" X 11" SHEET SIZE (W X H)							
19040	19040 7	White	13.7	1.9	6	6	EA
19041	19041 4	Black	13.7	1.9	6	6	EA
4" CAPACITY, 8½" X 11" SHEET SIZE (W X H)							
19050	19050 6	White	14.4	1.9	6	6	EA
19051	19051 3	Black	14.4	1.9	6	6	EA
5" CAPACITY, 8½" X 11" SHEET SIZE (W X H)							
19060	19060 5	White	7.1	0.8	2	2	EA
19061	19061 2	Black	7.1	0.8	2	2	EA

XTRAVUE™ CLEARVUE™ D-RING BINDERS

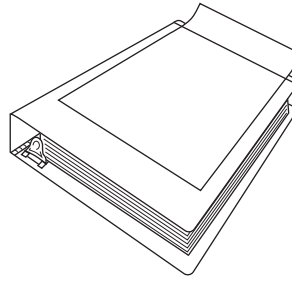

- Clear overlays on front, back and spine allows insertion of custom title sheets
- Slant-D® metal holds 25%-50% more than conventional round ring metals
- Horizontal pockets inside front and back
- XtraLife® Hinge provides added strength
- Flat poly sheet lifter
- MicroFine™ suede finish vinyl cover
- Recycled Content: 45% by material weight



ITEM NO.	ID NO. 83086 UPC	COLOR	CTN WT LBS	CTN CUBE	CTN QTY	MIN ORD QTY	U O M
1" CAPACITY, 8½" X 11" SHEET SIZE (W X H)							
17200	17200 7	White	15.3	1.0	12	12	EA
17201	17201 4	Black	15.3	1.0	12	12	EA
1½" CAPACITY, 8½" X 11" SHEET SIZE (W X H)							
17400	17400 1	White	18.6	1.3	12	12	EA
17401	17401 8	Black	18.6	1.3	12	12	EA
2" CAPACITY, 8½" X 11" SHEET SIZE (W X H)							
17500	17500 8	White	21.3	1.9	12	12	EA
17501	17501 5	Black	21.3	1.9	12	12	EA
3" CAPACITY, 8½" X 11" SHEET SIZE (W X H)							
17600	17600 5	White	13.8	1.9	6	6	EA
17601	17601 2	Black	13.8	1.9	6	6	EA
4" CAPACITY, 8½" X 11" SHEET SIZE (W X H)							
17810	17810 8	White	15.1	1.9	6	6	EA
17811	17811 5	Black	15.1	1.9	6	6	EA
5" CAPACITY, 8½" X 11" SHEET SIZE (W X H)							
17950	17950 1	White	7.1	0.8	2	2	EA
17951	17951 8	Black	7.1	0.8	2	2	EA

ROUND RING PRESENTATION BINDERS

SPINEVUE® LOCKING ROUNDRING BINDERS

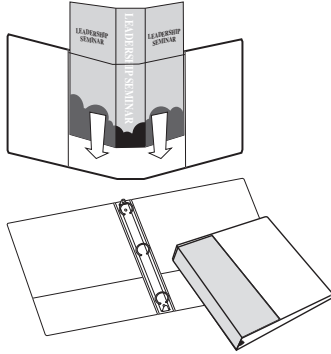

- Exclusive wrap-around clear overlay holds standard letter size sheets (8½" x 11")
- Easy to customize for presentation or filing—no trimming or fumbling with small spine inserts and separate cover inserts as needed for standard overlay binders
- FREE software templates from www.cardinalbrands.com/support
- Hidden/concealed rivet construction
- Leather-like vinyl cover material adds professional, premium look not found on standard overlay binders
- Contrasting black lining
- SureLock™ round ring metals stay aligned, won't accidentally open and spill contents (1" through 3")
- Horizontal pockets inside front and back
- XtraLife® Hinge design for maximum strength
- Recycled
- Content: 45% by material weight



ITEM NO.	ID NO. 83086 UPC	COLOR	CTN WT LBS	CTN CUBE	CTN QTY	MIN ORD QTY	U O M
½" CAPACITY, 8½" X 11" SHEET SIZE (W X H)							
16101	16101 8	Black	12.8	0.7	12	12	EA
16102	16102 5	Navy	12.8	0.7	12	12	EA
16103	16103 2	White	12.8	0.7	12	12	EA
16158	16158 2	Maroon	12.8	0.7	12	12	EA
1" CAPACITY, 8½" X 11" SHEET SIZE (W X H)							
16301	16301 2	Black	13.4	1.0	12	12	EA
16302	16302 9	Navy	13.4	1.0	12	12	EA
16303	16303 6	White	13.4	1.0	12	12	EA
16358	16358 6	Maroon	13.4	1.0	12	12	EA
1½" CAPACITY, 8½" X 11" SHEET SIZE (W X H)							
16701	16701 0	Black	15.4	1.2	12	12	EA
16702	16702 7	Navy	15.4	1.2	12	12	EA
16703	16703 4	White	15.4	1.2	12	12	EA
16758	16758 4	Maroon	15.4	1.2	12	12	EA
2" CAPACITY, 8½" X 11" SHEET SIZE (W X H)							
16801	16801 7	Black	19.0	1.7	12	12	EA
16802	16802 4	Navy	19.0	1.7	12	12	EA
16803	16803 1	White	19.0	1.7	12	12	EA
16858	16858 1	Maroon	19.0	1.7	12	12	EA
3" CAPACITY, 8½" X 11" SHEET SIZE (W X H)							
16901	16901 4	Black	13.7	1.1	6	6	EA
16902	16902 1	Navy	13.7	1.1	6	6	EA
16903	16903 8	White	13.7	1.1	6	6	EA
16958	16958 8	Maroon	13.7	1.1	6	6	EA

ROUND RING PRESENTATION BINDERS (Heavy-duty, Active Use)

EASYOPEN® CLEARVUE™ LOCKING ROUND RING BINDERS

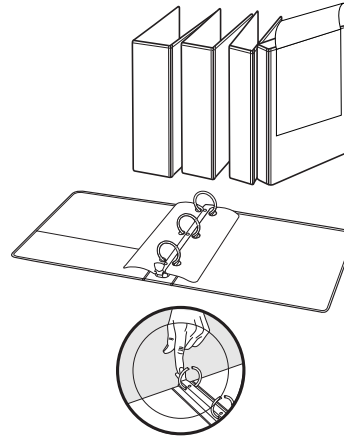

- Opens and closes with just the touch of one finger
- "Ease-of-Use" Commendation from Arthritis Foundation
- Safer and easier to use than any other ring metal
- No more pinched fingers
- Lock engages instantly when closed, eliminating the two-step and two-handed operation
- No more scratched desks or bookshelves from triggers that don't close up
- Clear overlay on front, back and spine allows insertion of custom title sheets
- Horizontal pockets inside front and back covers
- Two curved poly sheet lifters included on 1½" through 3" capacities
- Recycled Content: 44% by material weight
- FREE software templates from www.cardinalbrands.com/support



ITEM NO.	ID NO. 83086 UPC	COLOR	CTN WT LBS	CTN CUBE	CTN QTY	MIN ORD QTY	U O M
1" CAPACITY, 8½" X 11" SHEET SIZE (W X H)							
11100	11100 6	White	11.6	0.9	12	12	EA
11101	11101 3	Black	11.6	0.9	12	12	EA
1½" CAPACITY, 8½" X 11" SHEET SIZE (W X H)							
11110	11110 5	White	13.0	1.2	12	12	EA
11111	11111 2	Black	13.0	1.2	12	12	EA
2" CAPACITY, 8½" X 11" SHEET SIZE (W X H)							
11120	11120 4	White	16.3	1.7	12	12	EA
11121	11121 1	Black	16.3	1.7	12	12	EA
3" CAPACITY, 8½" X 11" SHEET SIZE (W X H)							
11130	11130 3	White	9.6	1.1	6	6	EA
11131	11131 0	Black	9.6	1.1	6	6	EA



ROUND RING PRESENTATION BINDERS

THE PRESENTER CLEARVUE™ ROUNDING BINDERS (HIDDEN RIVET)

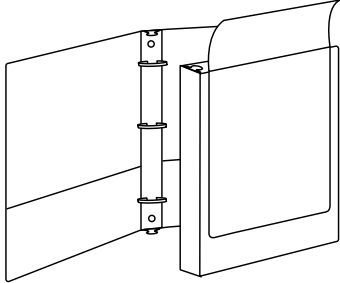

- Clear overlays on front, back and spine allows insertion of custom title sheets
- Hidden/concealed rivet construction
- Horizontal pockets inside front and back
- Smooth vinyl finish
- Poly sheet lifters provided on 2" and 3" size
- SureLock™ locking round ring metal with double triggers (1" through 3")
- Recycled Content: 48% by material weight



ITEM NO.	ID NO. 83086 UPC	COLOR	CTN WT LBS	CTN CUBE	CTN QTY	MIN ORD QTY	U O M
½" CAPACITY, 8½" X 11" SHEET SIZE (W X H)							
01214	01214 3	White	10.4	0.7	12	12	EA
01213	01213 6	Black	10.4	0.7	12	12	EA
1" CAPACITY, 8½" X 11" SHEET SIZE (W X H)							
01244	01244 0	White	12.5	0.9	12	12	EA
01233	01233 4	Black	12.5	0.9	12	12	EA
1½" CAPACITY, 8½" X 11" SHEET SIZE (W X H)							
01444	01444 4	White	13.1	1.2	12	12	EA
01433	01433 8	Black	13.1	1.2	12	12	EA
2" CAPACITY, 8½" X 11" SHEET SIZE (W X H)							
01544	01544 1	White	17.5	1.7	12	12	EA
01533	01533 5	Black	17.5	1.7	12	12	EA
3" CAPACITY, 8½" X 11" SHEET SIZE (W X H)							
01644	01644 8	White	20.6	2.1	12	12	EA
01633	01633 2	Black	20.6	2.1	12	12	EA

PREMIUM CLEARVUE™ ROUNDING BINDERS

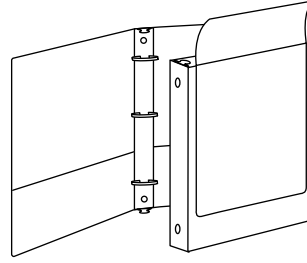

- Clear overlays on front, back and spine allows insertion of custom title sheets
- SureLock™ locking rings stay aligned, won't accidentally open and spill contents (1" through 3")
- Vinyl covers with smooth suedene finish
- XtraLife® Hinge provides added strength
- Horizontal pockets inside front and back
- Poly sheet lifter provided on 1" and up
- Recycled Content: 48% by material weight
- Heavy weight board construction



ITEM NO.	ID NO. 83086 UPC	COLOR	CTN WT LBS	CTN CUBE	CTN QTY	MIN ORD QTY	U O M
½" CAPACITY, 8½" X 11" SHEET SIZE (W X H)							
04100	04100 6	White	12.8	0.7	12	12	EA
04101	04101 3	Black	12.8	0.7	12	12	EA
04142	04142 6	Blue	12.8	0.7	12	12	EA
1" CAPACITY, 8½" X 11" SHEET SIZE (W X H)							
04200	04200 3	White	7.6	0.6	6	6	EA
04201	04201 0	Black	14.8	0.9	12	12	EA
04242	04242 3	Blue	14.8	0.9	12	12	EA
1½" CAPACITY, 8½" X 11" SHEET SIZE (W X H)							
04400	04400 7	White	16.9	1.2	12	12	EA
04401	04401 4	Black	16.9	1.2	12	12	EA
04442	04442 7	Blue	16.9	1.2	12	12	EA
2" CAPACITY, 8½" X 11" SHEET SIZE (W X H)							
04500	04500 4	White	21.7	1.7	12	12	EA
04501	04501 1	Black	21.7	1.7	12	12	EA
04506	04506 6	White	10.3	0.8	6	6	EA
04542	04542 4	Blue	21.7	1.7	12	12	EA
3" CAPACITY, 8½" X 11" SHEET SIZE (W X H)							
04600	04600 1	White	22.4	2.1	12	12	EA
04601	04601 8	Black	22.4	2.1	12	12	EA
04642	04642 1	Blue	22.4	2.1	12	12	EA

ROUND RING PRESENTATION BINDERS

BASIC VALUE® CLEARVUE™ ROUNDING BINDERS

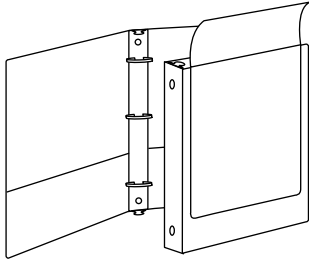

- Clear overlays on front, back and spine allows insertion of custom title sheets
- MicroFine™ Suede vinyl finish cover material
- Dual opening and closing round ring metal with triggers
- Horizontal pocket inside front and back
- XtraLife® Hinge provides durability
- Sheet lifter provided for 2" and 3" size binders
- Assorted colors: green, purple, navy, bright blue
- Recycled Content: 43% by material weight



ITEM NO.	ID NO. 83086 UPC	COLOR	CTN WT LBS	CTN CUBE	CTN QTY	MIN ORD QTY	U O M
¾" CAPACITY, 8½" X 11" SHEET SIZE (W X H)							
01100	01100 9	White	9.9	0.7	12	12	EA
01101	01101 6	Black	9.9	0.7	12	12	EA
1" CAPACITY, 8½" X 11" SHEET SIZE (W X H)							
01200	01200 6	White	10.6	0.9	12	12	EA
01200U	01298 3	White PDQ	5.5	0.6	6	6	EA
01201	01201 3	Black	10.6	0.9	12	12	EA
01205	01205 1	Forest Green	10.6	0.9	12	12	EA
01242	01242 6	Blue	10.6	0.9	12	12	EA
01247	01247 5	Navy	10.6	0.9	12	12	EA
01257	01257 2	Purple	10.6	0.9	12	12	EA
01268	01268 6	Assorted Fashion Colors	5.4	0.5	6	6	EA
1½" CAPACITY, 8½" X 11" SHEET SIZE (W X H)							
01400	01400 0	White	11.6	1.2	12	12	EA
01400U	01498 7	White PDQ	6.7	0.7	6	6	EA
01401	01401 7	Black	11.6	1.2	12	12	EA
01405	01405 1	Forest Green	11.6	1.2	12	12	EA
01442	01442 0	Blue	11.6	1.2	12	12	EA
01447	01447 5	Navy	11.6	1.2	12	12	EA
01457	01457 2	Purple	11.6	1.2	12	12	EA
01468	01468 0	Assorted Fashion Colors PDQ	6.7	0.7	6	6	EA
2" CAPACITY, 8½" X 11" SHEET SIZE (W X H)							
01500	01500 7	White	15.2	1.7	12	12	EA
01506U	01506 9	White	7.5	0.8	6	6	EA
01501	01501 4	Black	15.2	1.7	12	12	EA
01505	01505 0	Forest Green	15.2	1.7	12	12	EA
01542	01542 7	Blue	15.2	1.7	12	12	EA
01547	01547 4	Navy	15.2	1.7	12	12	EA
01557	01557 1	Purple	15.2	1.7	12	12	EA
3" CAPACITY, 8½" X 11" SHEET SIZE (W X H)							
01600	01600 4	White	20.8	2.1	12	12	EA
01601	01601 1	Black	20.8	2.1	12	12	EA
01642	01642 4	Blue	20.8	2.1	12	12	EA

"U" denotes flysheet included.

ECONOMYVALUE™ CLEARVUE™ ROUNDING BINDERS

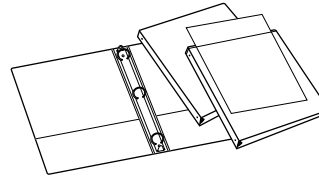

- Clear overlay on front, back and spine for custom inserts
- Dual opening and closing ring metal triggers
- Horizontal clear vinyl pocket inside front and back covers
- Recycled Content: 45% by material weight



ITEM NO.	ID NO. 83086 UPC	COLOR	CTN WT LBS	CTN CUBE	CTN QTY	MIN ORD QTY	U O M
¾" CAPACITY, 8½" X 11" SHEET SIZE (W X H)							
04000	04000 9	White	8.8	0.7	12	12	EA
1" CAPACITY, 8½" X 11" SHEET SIZE (W X H)							
04010	04010 8	White	10.7	0.9	12	12	EA
1½" CAPACITY, 8½" X 11" SHEET SIZE (W X H)							
04015	04015 3	White	11.7	1.2	12	12	EA
2" CAPACITY, 8½" X 11" SHEET SIZE (W X H)							
04020	04020 7	White	13.0	1.7	12	12	EA
3" CAPACITY, 8½" X 11" SHEET SIZE (W X H)							
04030	04030 6	White	10.1	1.1	6	6	EA



ROUND RING PRESENTATION BINDERS

CLEARTRU™ BINDERS

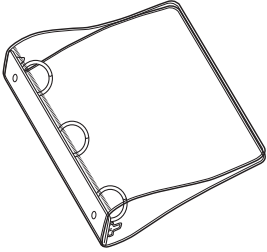

- Flexible clear vinyl cover
- Clear cover adds brilliance to any title page
- Ideal for company catalog and image books, proposals and presentations
- FREE software templates from www.cardinalbrands.com/support



ITEM NO.	ID NO. 83086 UPC	COLOR	CTN WT LBS	CTN CUBE	CTN QTY	MIN ORD QTY	U O M
¾" CAPACITY, 8½" X 11" SHEET SIZE (W X H)							
09191	09191 9	Clear	8.1	0.9	12	12	EA
1" CAPACITY, 8½" X 11" SHEET SIZE (W X H)							
09192	09192 6	Clear	8.9	1.2	12	12	EA
09192M	09192 6	Clear PDQ	9.7	1.3	12	12	EA
1½" CAPACITY, 8½" X 11" SHEET SIZE (W X H)							
09193	09193 3	Clear	15.1	1.5	12	12	EA

EASEL RING BINDERS

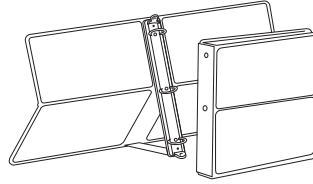

- Attractive linen printed outside vinyl material
- Contrasting black lining
- Double booster round ring metal
- Available in vertical and horizontal positions
- Recycled Content: 40% by material weight

VERTICAL

- Bottom half of binder swings back from ring to form easel stand
- Vinyl strap secures easel stand in place
- Contents can be viewed in normal vertical position

HORIZONTAL

- Distinguished scored binder cover contains a Velcro® closer
- Cover folds back to hold binder secure when in use

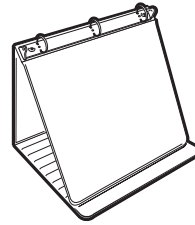

ITEM NO.	ID NO. 83086 UPC	COLOR	CTN WT LBS	CTN CUBE	CTN QTY	MIN ORD QTY	U O M
VERTICAL, 1" CAPACITY, 8½" X 11" SHEET SIZE (W X H)							
09261	09261 9	Black Linen	12.9	0.9	12	12	EA
HORIZONTAL, 1" CAPACITY, 11" X 8½" SHEET SIZE (W X H)							
09260	09260 2	Black Linen	12.9	0.9	12	12	EA

D-RING REFERENCE BINDERS (Heavy-duty, Active Use)

SLANT-D® LOCKING RING BINDERS

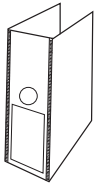
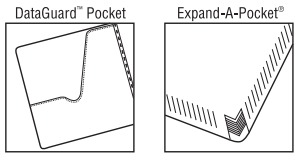
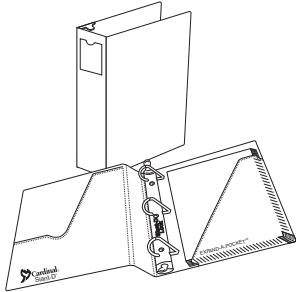

- Slant-D® locking rings secures binder contents and keeps ring wires aligned
- Holds 25%-50% more than conventional round ring binders
- Patented Expand-A-Pocket® in back expands to hold up to 1/2" stack of materials
- Exclusive patented DataGuard™ Pocket inside front prevents document damage
- Made with strongest, heaviest virgin vinyl in industry. MicroFine™ Suede finish vinyl cover.
- Stands up to years of use with XtraLife® Hinge and BlindEdge™ Weld
- Finger hole in 5" capacity for easy shelf removal
- Flat poly sheet lifter
- Recycled Content: 45% by material weight



ITEM NO.	ID NO. 83086 UPC	COLOR	CTN WT LBS	CTN CUBE	CTN QTY	MIN ORD QTY	U O M
1" CAPACITY, 8½" X 11" SHEET SIZE (W X H)							
11232	11232 4	Black	16.7	1.0	12	12	EA
11242	11242 3	Blue	16.7	1.0	12	12	EA
11247	11247 8	Navy	16.7	1.0	12	12	EA
11252	11252 2	Red	16.7	1.0	12	12	EA
11257	11257 7	Maroon	16.7	1.0	12	12	EA
1½" CAPACITY, 8½" X 11" SHEET SIZE (W X H)							
11432	11432 8	Black	22.0	1.3	12	12	EA
11442	11442 7	Blue	22.0	1.3	12	12	EA
11447	11447 2	Navy	22.0	1.3	12	12	EA
11452	11452 6	Red	22.0	1.3	12	12	EA
11457	11457 1	Maroon	22.0	1.3	12	12	EA
2" CAPACITY, 8½" X 11" SHEET SIZE (W X H)							
11532	11532 5	Black	25.1	1.9	12	12	EA
11537	11537 0	Gray	25.1	1.9	12	12	EA
11542	11542 4	Blue	25.1	1.9	12	12	EA
11547	11547 9	Navy	25.1	1.9	12	12	EA
11552	11552 3	Red	25.1	1.9	12	12	EA
11557	11557 8	Maroon	25.1	1.9	12	12	EA
3" CAPACITY, 8½" X 11" SHEET SIZE (W X H)							
11632	11632 2	Black	14.5	1.9	6	6	EA
11637	11637 7	Gray	14.5	1.9	6	6	EA
11642	11642 1	Blue	14.5	1.9	6	6	EA
11647	11647 6	Navy	14.5	1.9	6	6	EA
11652	11652 0	Red	14.5	1.9	6	6	EA
11657	11657 5	Maroon	14.5	1.9	6	6	EA

(continued in next column)

SLANT-D® LOCKING RING BINDERS (CONTINUED)

ITEM NO.	ID NO. 83086 UPC	COLOR	CTN WT LBS	CTN CUBE	CTN QTY	MIN ORD QTY	U O M
4" CAPACITY, 8½" X 11" SHEET SIZE (W X H)							
11832	11832 6	Black	15.1	2.4	6	6	EA
11837	11837 1	Gray	15.1	2.4	6	6	EA
11842	11842 5	Blue	15.1	2.4	6	6	EA
11847	11847 0	Navy	15.1	2.4	6	6	EA
11852	11852 4	Red	15.1	2.4	6	6	EA
11857	11857 9	Maroon	15.1	2.4	6	6	EA
5" CAPACITY, 8½" X 11" SHEET SIZE (W X H)							
11932	11932 3	Black	7.0	0.8	2	2	EA
11937	11937 8	Gray	7.0	0.8	2	2	EA
11942	11942 2	Blue	7.0	0.8	2	2	EA
11947	11947 7	Navy	7.0	0.8	2	2	EA
11952	11952 1	Red	7.0	0.8	2	2	EA
11957	11957 6	Maroon	7.0	0.8	2	2	EA
BINDERS W/LABEL HOLDER, 8½" X 11" SHEET SIZE (W X H)							
11222	11222 5	1" Black	16.7	1.0	12	12	EA
11422	11422 9	1½" Black	22.0	1.3	12	12	EA
11522	11522 6	2" Black	25.1	1.9	12	12	EA
11622	11622 3	3" Black	14.5	1.9	6	6	EA
11822	11822 7	4" Black	15.1	2.4	6	6	EA
11922	11922 4	5" Black	7.0	0.8	2	2	EA

NEW EASYOPEN® WORKPLACE™ LOCKING SLANT-D® RING BINDERS

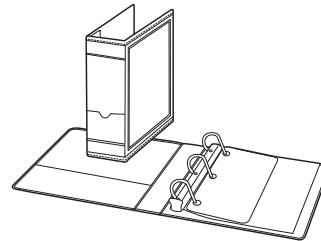

- Attractive black fabric cover over extra-durable E.V.A. molded foam base
- No pinch EasyOpen locking Slant-D rings operate with one touch
- Nylon reinforced hinges are guaranteed for life
- Cover is cold-tested to 10°F
- Remains comfortable to the touch in any temperature
- Inside front and back pockets
- Generous size label holder
- Received the "Ease-of-Use" Commendation from the Arthritis Foundation
- FREE software templates from www.cardinalbrands.com/support



ITEM NO.	ID NO. 83086 UPC	COLOR	CTN WT LBS	CTN CUBE	CTN QTY	MIN ORD QTY	U O M
1½" CAPACITY, 8½" X 11" SHEET SIZE (W X H)							
14812	14812 5	Black	10.4	0.9	6	6	EA
2" CAPACITY, 8½" X 11" SHEET SIZE (W X H)							
14822	14822 4	Black	11.8	1.0	6	6	EA
3" CAPACITY, 8½" X 11" SHEET SIZE (W X H)							
14832	14832 3	Black	13.5	1.3	6	6	EA



D-RING REFERENCE BINDERS (Active Use)

EASYOPEN® LOCKING D-RING BINDERS

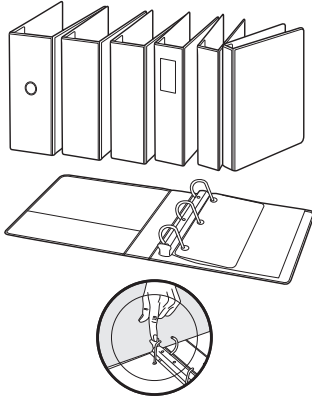

- Opens and closes with just the touch of one finger
- "Ease-of-Use" Commendation from Arthritis Foundation
- Safer and easier to use than any other ring metal
- No more pinched fingers
- Lock engages instantly when closed, eliminating the two-step and two-handed operation
- No scratched desks or bookshelves from triggers that don't close up
- Holds 25% more sheets than standard round ring binder
- Contrasting black lining provides professional look
- Horizontal pockets inside front and back covers
- Flat poly sheet lifter included
- Recycled content: 44% by material weight



ITEM NO.	ID NO. 83086 UPC	COLOR	CTN WT LBS	CTN CUBE	CTN QTY	MIN ORD QTY	U O M
1" CAPACITY, 8½" X 11" SHEET SIZE (W X H)							
18712	18712 4	Black	13.5	1.0	12	12	EA
18713	18713 1	Navy	13.5	1.0	12	12	EA
18716	18716 2	Burgundy	13.5	1.0	12	12	EA
18717	18717 9	Medium Blue	13.5	1.0	12	12	EA
18718	18718 6	Red	13.5	1.0	12	12	EA
1½" CAPACITY, 8½" X 11" SHEET SIZE (W X H)							
18722	18722 3	Black	15.0	1.3	12	12	EA
18723	18723 0	Navy	15.0	1.3	12	12	EA
18726	18726 1	Burgundy	15.0	1.3	12	12	EA
18727	18727 8	Medium Blue	15.0	1.3	12	12	EA
18728	18728 5	Red	15.0	1.3	12	12	EA
2" CAPACITY, 8½" X 11" SHEET SIZE (W X H)							
18732	18732 2	Black	18.5	1.9	12	12	EA
18733	18733 9	Navy	18.5	1.9	12	12	EA
18736	18736 0	Burgundy	18.5	1.9	12	12	EA
18737	18737 7	Medium Blue	18.5	1.9	12	12	EA
18738	18738 4	Red	18.5	1.9	12	12	EA
3" CAPACITY, 8½" X 11" SHEET SIZE (W X H)							
18742	18742 1	Black	12.0	1.9	6	6	EA
18743	18743 8	Navy	12.0	1.9	6	6	EA
18746	18746 9	Burgundy	12.0	1.9	6	6	EA
18747	18747 6	Medium Blue	12.0	1.9	6	6	EA
18748	18748 3	Red	12.0	1.9	6	6	EA

(continued on next column)

EASYOPEN® LOCKING D-RING BINDERS (CONTINUED)

ITEM NO.	ID NO. 83086 UPC	COLOR	CTN WT LBS	CTN CUBE	CTN QTY	MIN ORD QTY	U O M
4" CAPACITY, 8½" X 11" SHEET SIZE (W X H)							
18752	18752 0	Black	14.0	1.9	6	6	EA
18753	18753 7	Navy	14.0	1.9	6	6	EA
18756	18756 8	Burgundy	14.0	1.9	6	6	EA
18757	18757 5	Medium Blue	14.0	1.9	6	6	EA
18758	18758 2	Red	14.0	1.9	6	6	EA
5" CAPACITY, 8½" X 11" SHEET SIZE (W X H)							
18762	18762 9	Black	5.7	0.8	2	2	EA
18763	18763 6	Navy	5.7	0.8	2	2	EA
18766	18766 7	Burgundy	5.7	0.8	2	2	EA
18767	18767 4	Medium Blue	5.7	0.8	2	2	EA
18768	18768 1	Red	5.7	0.8	2	2	EA
BINDERS W/LABEL HOLDER, 8½" X 11" SHEET SIZE (W X H)							
18711	18711 7	1", Black	13.6	1.0	12	12	EA
18721	18721 6	1½", Black	15.7	1.3	12	12	EA
18731	18731 5	2", Black	18.6	1.9	12	12	EA
18741	18741 4	3", Black	12.1	1.9	6	6	EA
18751	18751 3	4", Black	14.1	1.9	6	6	EA
18761	18761 2	5", Black	5.8	0.8	2	2	EA

EASYOPEN® SUPERLIFE™ D-RING BINDERS (Heavy-duty, Active Use – Lifetime Guarantee on Cover)

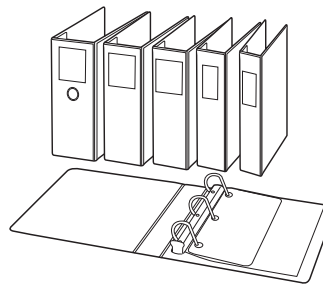

- Opens and closes with just the touch of one finger
- "Ease-of-Use" Commendation from Arthritis Foundation
- Safer and easier to use than any other ring metal
- Transfer-safe polypropylene will not lift inks and toners
- Safe for all documents and photos
- Dual-fold™ living hinge is guaranteed to not crack or breakdown
- Heavy duty construction
- Manufacturers lifetime warranty on the cover



ITEM NO.	ID NO. 83086 UPC	COLOR	CTN WT LBS	CTN CUBE	CTN QTY	MIN ORD QTY	U O M
1½" CAPACITY, 8½" X 11" SHEET SIZE (W X H)							
14012	14012 9	Black	15.6	1.7	12	12	EA
2" CAPACITY, 8½" X 11" SHEET SIZE (W X H)							
14022	14022 8	Black	19.2	1.9	12	12	EA
3" CAPACITY, 8½" X 11" SHEET SIZE (W X H)							
14032	14032 7	Black	12.0	1.9	6	6	EA
4" CAPACITY, 8½" X 11" SHEET SIZE (W X H)							
14042	14042 6	Black	14.2	1.9	6	6	EA
5" CAPACITY, 8½" X 11" SHEET SIZE (W X H)							
14052	14052 5	Black	6.0	0.8	2	2	EA

D-RING REFERENCE BINDERS (Active Use)

PRESTIGE LOCKING D-RING BINDERS

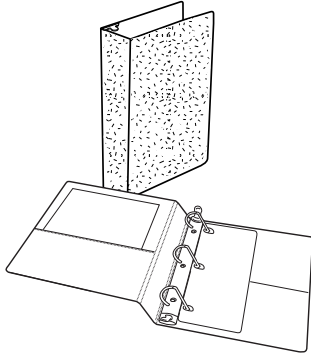

- Exclusive surface texture and two-tone color
- Professional styling for today's office environment
- Heavy duty construction
- Contrasting black lining and pockets
- Horizontal inside pockets
- Slant-D® locking rings with GelTab™ triggers secure binder contents and keeps ring wires aligned. Holds 25% more than conventional round ring binders
- Sheet size – 8½"x11"
- Recycled content 45% by material weight



ITEM NO.	ID NO. 83086 UPC	COLOR	CTN WT LBS	CTN CUBE	CTN QTY	MIN ORD QTY	U O M
1" CAPACITY, 8½" X 11" SHEET SIZE (W X H)							
18012	18012 5	Black	10.8	1.0	12	12	EA
18013	18013 2	Dark Blue	10.8	1.0	12	12	EA
18014	18014 9	Evergreen	10.8	1.0	12	12	EA
18016	18016 3	Maroon	10.8	1.0	12	12	EA
18017	18017 0	Medium Blue	10.8	1.0	12	12	EA
18018	18018 7	Red	10.8	1.0	12	12	EA
1½" CAPACITY, 8½" X 11" SHEET SIZE (W X H)							
18022	18022 4	Black	11.8	1.3	12	12	EA
18023	18023 1	Dark Blue	11.8	1.3	12	12	EA
18024	18024 8	Evergreen	11.8	1.3	12	12	EA
18026	18026 2	Maroon	11.8	1.3	12	12	EA
18027	18027 9	Medium Blue	11.8	1.3	12	12	EA
18028	18028 6	Red	11.8	1.3	12	12	EA
2" CAPACITY, 8½" X 11" SHEET SIZE (W X H)							
18032	18032 3	Black	15.8	1.9	12	12	EA
18033	18033 0	Dark Blue	15.8	1.9	12	12	EA
18034	18034 7	Evergreen	15.8	1.9	12	12	EA
18036	18036 1	Maroon	15.8	1.9	12	12	EA
18037	18037 8	Medium Blue	15.8	1.9	12	12	EA
18038	18038 5	Red	15.8	1.9	12	12	EA
18130	18130 6	Assorted	7.9	1.0	6	6	EA
3" CAPACITY, 8½" X 11" SHEET SIZE (W X H)							
18042	18042 2	Black	13.7	1.9	6	6	EA
18043	18043 9	Dark Blue	13.7	1.9	6	6	EA
18044	18044 6	Evergreen	13.7	1.9	6	6	EA
18046	18046 0	Maroon	13.7	1.9	6	6	EA
18047	18047 7	Medium Blue	13.7	1.9	6	6	EA
18048	18048 4	Red	13.7	1.9	6	6	EA
18150	18150 4	Assorted	13.7	1.9	6	6	EA

(continued on next column)

PRESTIGE LOCKING D-RING BINDERS (CONTINUED)

ITEM NO.	ID NO. 83086 UPC	COLOR	CTN WT LBS	CTN CUBE	CTN QTY	MIN ORD QTY	U O M
4" CAPACITY, 8½" X 11" SHEET SIZE (W X H)							
18052	18052 1	Black	14.5	1.9	6	6	EA
18053	18053 8	Dark Blue	14.5	1.9	6	6	EA
18054	18054 5	Evergreen	14.5	1.9	6	6	EA
18056	18056 9	Maroon	14.5	1.9	6	6	EA
18057	18057 6	Medium Blue	14.5	1.9	6	6	EA
18058	18058 3	Red	14.5	1.9	6	6	EA
5" CAPACITY, 8½" X 11" SHEET SIZE (W X H)							
18062	18062 0	Black	6.5	0.8	2	2	EA
18063	18063 7	Dark Blue	6.5	0.8	2	2	EA
18064	18064 4	Evergreen	6.5	0.8	2	2	EA
18066	18066 8	Maroon	6.5	0.8	2	2	EA
18067	18067 5	Medium Blue	6.5	0.8	2	2	EA
18068	18068 2	Red	6.5	0.8	2	2	EA
BINDERS W/LABEL HOLDER, 8½" X 11" SHEET SIZE (W X H)							
18011	18011 8	1", Black	10.8	1.0	12	12	EA
18021	18021 7	1½", Black	11.8	1.3	12	12	EA
18031	18031 6	2", Black	15.8	1.9	12	12	EA
18041	18041 5	3", Black	13.7	1.9	6	6	EA
18051	18051 4	4", Black	14.5	1.9	6	6	EA
18061	18061 3	5", Black	6.5	0.8	2	2	EA



D-RING STORAGE BINDERS

XTRAVALUE™ LOCKING D-RING BINDERS WITH LABEL HOLDERS

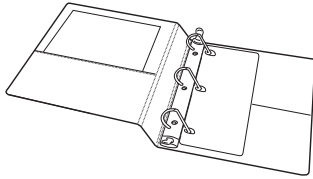

- Locking Slant-D® metals hold 25% more than conventional round non-locking rings
- Horizontal pockets inside front and back
- Stands up to years of use with XtraLife® Hinge
- MicroFine™ Suede Finish vinyl cover
- Flat poly sheet lifter included
- Label holders on every binder
- Recycled Content: 49% by material weight



LOCKING

ITEM NO.	ID NO. 83086 UPC	COLOR	CTN WT LBS	CTN CUBE	CTN QTY	MIN ORD QTY	U O M
1" CAPACITY, 8½" X 11" SHEET SIZE (W X H)							
18010	18010 1	Assorted	6.3	0.5	6	6	EA
1½" CAPACITY, 8½" X 11" SHEET SIZE (W X H)							
18020	18020 0	Assorted PDQ	7.1	0.7	6	6	EA
2" CAPACITY, 8½" X 11" SHEET SIZE (W X H)							
18030	18030 9	Assorted PDQ	10.0	1.0	6	6	EA

XTRAVALUE™ D-RING BINDERS

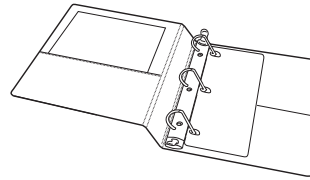

- Slant-D® metals hold 25% more than conventional round non-locking rings
- Horizontal pockets inside front and back
- Stands up to years of use with XtraLife® Hinge
- MicroFine™ Suede Finish vinyl cover
- Flat poly sheet lifter included
- Recycled Content: 49% by material weight



ITEM NO.	ID NO. 83086 UPC	COLOR	CTN WT LBS	CTN CUBE	CTN QTY	MIN ORD QTY	U O M
1" CAPACITY, 8½" X 11" SHEET SIZE (W X H)							
XV204	99204 9	White	14.8	0.9	12	12	EA
XV232	99232 2	Black	14.8	0.9	12	12	EA
XV242	99242 1	Blue	14.8	0.9	12	12	EA
XV247	99247 6	Navy	14.8	0.9	12	12	EA
XV252	99252 0	Red	14.8	0.9	12	12	EA
1½" CAPACITY, 8½" X 11" SHEET SIZE (W X H)							
XV404	99404 3	White	17.4	1.3	12	12	EA
XV432	99432 6	Black	17.4	1.3	12	12	EA
XV442	99442 5	Blue	17.4	1.3	12	12	EA
XV447	99447 0	Navy	17.4	1.3	12	12	EA
XV452	99452 4	Red	17.4	1.3	12	12	EA
18020	18020 0	Assorted PDQ	x	0.7	6	6	EA
2" CAPACITY, 8½" X 11" SHEET SIZE (W X H)							
XV504	99504 0	White	23.3	1.9	12	12	EA
XV532	99532 3	Black	23.3	1.9	12	12	EA
XV542	99542 2	Blue	23.3	1.9	12	12	EA
XV547	99547 7	Navy	23.3	1.9	12	12	EA
XV552	99552 1	Red	23.3	1.9	12	12	EA
18030	18030 9	Assorted PDQ	x	1.0	6	6	EA
3" CAPACITY, 8½" X 11" SHEET SIZE (W X H)							
XV604	99604 7	White	12.8	1.9	6	6	EA
XV632	99632 0	Black	12.8	1.9	6	6	EA
XV642	99642 9	Blue	12.8	1.9	6	6	EA
XV647	99647 4	Navy	12.8	1.9	6	6	EA
XV652	99652 8	Red	12.8	1.9	6	6	EA
4" CAPACITY, 8½" X 11" SHEET SIZE (W X H)							
XV832	99832 4	Black	14.5	2.4	6	6	EA
XV842	99842 3	Blue	14.5	2.4	6	6	EA
XV847	99847 8	Navy	14.5	2.4	6	6	EA
XV852	99852 2	Red	14.5	2.4	6	6	EA

ROUND RING REFERENCE BINDERS (Active Use)

EASYOPEN® LOCKING ROUND RING BINDERS

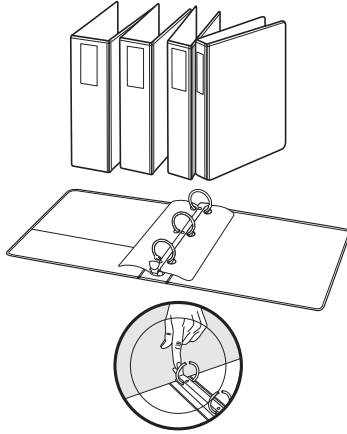

- Opens and closes with just the touch of one finger
- "Ease-of-Use" Commendation from Arthritis Foundation
- Safer and easier to use than any other ring metal
- No more pinched fingers
- Lock engages instantly when closed, eliminating the two-step and two-handed operation
- No more scratched desks or bookshelves from triggers that don't close up
- Contrasting black lining provides professional look
- Horizontal pockets inside front and back covers
- Two curved poly sheet lifters included
- Label holders on every binder
- Recycled Content: 44% by material weight



ITEM NO.	ID NO. 83086 UPC	COLOR	CTN WT LBS	CTN CUBE	CTN QTY	MIN ORD QTY	U O M
1" CAPACITY, 8½" X 11" SHEET SIZE (W X H)							
18812	18812 1	Black	11.8	0.9	12	12	EA
18813	18813 8	Navy	11.8	0.9	12	12	EA
18816	18816 9	Maroon	11.8	0.9	12	12	EA
18817	18817 6	Medium Blue	11.8	0.9	12	12	EA
18818	18818 3	Red	11.8	0.9	12	12	EA
1½" CAPACITY, 8½" X 11" SHEET SIZE (W X H)							
18822	18822 0	Black	13.6	1.2	12	12	EA
18823	18823 7	Navy	13.6	1.2	12	12	EA
18826	18826 8	Maroon	13.6	1.2	12	12	EA
18827	18827 5	Medium Blue	13.6	1.2	12	12	EA
18828	18828 2	Red	13.6	1.2	12	12	EA
2" CAPACITY, 8½" X 11" SHEET SIZE (W X H)							
18832	18832 9	Black	16.5	1.7	12	12	EA
18833	18833 6	Navy	16.5	1.7	12	12	EA
18836	18836 7	Maroon	16.5	1.7	12	12	EA
18837	18837 4	Medium Blue	16.5	1.7	12	12	EA
18838	18838 1	Red	16.5	1.7	12	12	EA
3" CAPACITY, 8½" X 11" SHEET SIZE (W X H)							
18842	18842 8	Black	10.0	1.1	6	6	EA
18843	18843 5	Navy	10.0	1.1	6	6	EA
18846	18846 6	Maroon	10.0	1.1	6	6	EA
18847	18847 3	Medium Blue	10.0	1.1	6	6	EA
18848	18848 0	Red	10.0	1.1	6	6	EA

PRESTIGE LOCKING ROUND RING BINDERS

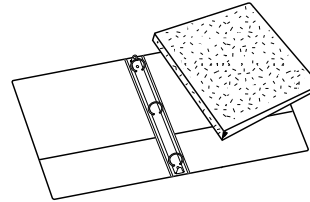

- Exclusive surface texture and two-tone color
- Professional styling for today's office environment
- Heavy duty construction
- Contrasting black lining and pockets
- Horizontal inside pockets
- SureLock™ round rings stay aligned, won't accidentally open and spill contents
- Sheet size – 8½"x11"
- Recycled content 45% by material weight



ITEM NO.	ID NO. 83086 UPC	COLOR	CTN WT LBS	CTN CUBE	CTN QTY	MIN ORD QTY	U O M
1" CAPACITY, 8½" X 11" SHEET SIZE (W X H)							
17912	17912 9	Black	10.8	1.0	12	12	EA
17913	17913 6	Dark Blue	10.8	1.0	12	12	EA
17914	17914 3	Evergreen	10.8	1.0	12	12	EA
17915	17915 0	Gray	10.8	1.0	12	12	EA
17916	17916 7	Maroon	10.8	1.0	12	12	EA
17917	17917 4	Medium Blue	10.8	1.0	12	12	EA
17918	17918 1	Red	10.8	1.0	12	12	EA
1½" CAPACITY, 8½" X 11" SHEET SIZE (W X H)							
17922	17922 8	Black	11.8	1.2	12	12	EA
17923	17923 5	Dark Blue	11.8	1.2	12	12	EA
17924	17924 2	Evergreen	11.8	1.2	12	12	EA
17925	17925 9	Gray	11.8	1.2	12	12	EA
17926	17926 6	Maroon	11.8	1.2	12	12	EA
17927	17927 3	Medium Blue	11.8	1.2	12	12	EA
17928	17928 0	Red	11.8	1.2	12	12	EA
2" CAPACITY, 8½" X 11" SHEET SIZE (W X H)							
17932	17932 7	Black	15.8	1.7	12	12	EA
17933	17933 4	Dark Blue	15.8	1.7	12	12	EA
17934	17934 1	Evergreen	15.8	1.7	12	12	EA
17935	17935 8	Gray	15.8	1.7	12	12	EA
17936	17936 5	Maroon	15.8	1.7	12	12	EA
17937	17937 2	Medium Blue	15.8	1.7	12	12	EA
17938	17938 9	Red	15.8	1.7	12	12	EA
BINDERS W/LABEL HOLDER, 8½" X 11" SHEET SIZE (W X H)							
17911	17911 2	1", Black	10.8	1.0	12	12	EA
17921	17921 1	1½", Black	11.8	1.2	12	12	EA
17931	17931 0	2", Black	15.8	1.7	12	12	EA
17941	17941 9	3", Black	13.7	1.1	6	6	EA
17943	17943 3	3", Dark Blue	13.7	1.1	6	6	EA
17944	17944 0	3", Evergreen	13.7	1.1	6	6	EA
17945	17945 7	3", Gray	13.7	1.1	6	6	EA
17946	17946 4	3", Maroon	13.7	1.1	6	6	EA
17947	17947 1	3", Medium Blue	13.7	1.1	6	6	EA
17948	17948 8	3", Red	13.7	1.1	6	6	EA



ROUND RING REFERENCE BINDERS
(Heavy-duty, Active Use)

XTRALIFE® NON-STICK LOCKING ROUND RING BINDERS

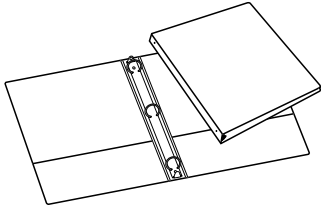

- Cover material will not transfer or lift ink from pages, has soft kid-leather texture
- XtraLife® material is stronger and will not tear or crack from cold temperature. **Binders are guaranteed for 1 full year against splitting along seams or hinge.**
- Cold crack tested to -50°F
- SureLock™ round rings stay aligned, won't accidentally open and spill contents
- Horizontal pockets inside front and back
- Assorted packs have same UPC number on binders in pack
- Recycled Content: 50% by material weight



ITEM NO.	ID NO. 83086 UPC	COLOR	CTN WT LBS	CTN CUBE	CTN QTY	MIN ORD QTY	U O M
1" CAPACITY, 8½" X 11" SHEET SIZE (W X H)							
25300	25300 3	Assorted PDQ	14.0	1.0	12	12	EA
25301	25301 0	Black	14.1	0.9	12	12	EA
25302	25302 7	Blue	14.1	0.9	12	12	EA
25337	25337 9	Gray	14.1	0.9	12	12	EA
1½" CAPACITY, 8½" X 11" SHEET SIZE (W X H)							
25700	25700 1	Assorted	14.9	1.2	12	12	EA
25701	25701 8	Black	14.9	1.2	12	12	EA
25702	25702 5	Blue	14.9	1.2	12	12	EA
25737	25737 7	Gray	14.9	1.2	12	12	EA
2" CAPACITY, 8½" X 11" SHEET SIZE (W X H)							
25800	25800 8	Assorted PDQ	9.0	1.0	6	6	EA
25801	25801 5	Black	17.9	1.8	12	12	EA
25802	25802 2	Blue	17.9	1.8	12	12	EA
25837	25837 4	Gray	17.9	1.8	12	12	EA
3" CAPACITY, 8½" X 11" SHEET SIZE (W X H)							
25900	25900 5	Assorted	10.3	1.2	6	6	EA

ROUND RING REFERENCE BINDERS

PERFORMER™ SERIES LOCKING ROUND RING BINDERS

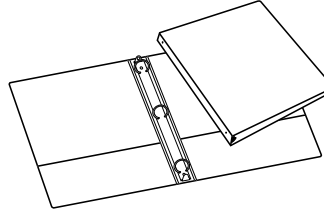

- SureLock™ round rings stay aligned, won't accidentally open and spill contents
- Leather grain textured vinyl covers with contrasting inside lining provides professional look
- Heavy weight board and construction
- XtraLife® Hinge provides added strength
- Horizontal pockets inside front and back
- Poly sheet lifter provided on 2" and 3" sizes
- Assorted packs contain black, blue and maroon and have same UPC number
- Recycled Content: 55% by material weight



ITEM NO.	ID NO. 83086 UPC	COLOR	CTN WT LBS	CTN CUBE	CTN QTY	MIN ORD QTY	U O M
1" CAPACITY, 8½" X 11" SHEET SIZE (W X H)							
15300	15300 6	Assorted PDQ	14.0	1.0	12	12	EA
2" CAPACITY, 8½" X 11" SHEET SIZE (W X H)							
15800	15800 1	Assorted PDQ	10.0	1.0	6	6	EA
3" CAPACITY, 8½" X 11" SHEET SIZE (W X H)							
15901	15901 5	Black PDQ	15.0	1.8	8	8	EA

LOCKING ROUND RING BINDERS

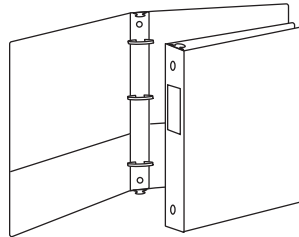

- SureLock™ round rings stay aligned, won't accidentally open and spill contents
- Vinyl covers with smooth suedene finish
- Horizontal pockets inside front and back
- Poly sheet lifter provided
- Label holders on every binder
- Assorted color packs. (All binders in pack have same UPC number)
- Recycled Content: 50% by material weight



ITEM NO.	ID NO. 83086 UPC	COLOR	CTN WT LBS	CTN CUBE	CTN QTY	MIN ORD QTY	U O M
1" CAPACITY, 8½" X 11" SHEET SIZE (W X H)							
09299	09299 2	Assorted (Single UPC) PDQ	7.0	0.6	6	6	EA
2" CAPACITY, 8½" X 11" SHEET SIZE (W X H)							
09599	09599 3	Assorted (Single UPC) PDQ	9.0	1.0	6	6	EA
3" CAPACITY, 8½" X 11" SHEET SIZE (W X H)							
09699	09699 0	Assorted (Single UPC)	7.6	0.7	4	4	EA

ROUND RING STORAGE BINDERS

BASIC VALUE® ROUNDING BINDERS

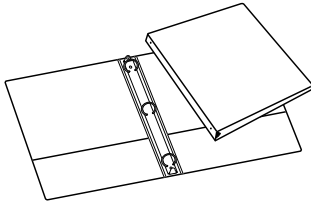

- MicroFine™ Suede Finish vinyl cover material
- Dual opening and closing ring metal triggers
- Horizontal pocket inside front and back
- XtraLife® Hinge provides durability
- Sheet lifter provided for 2" and 3" size binders
- Assorted packs have same UPC code on each product in pack, except for #00100, 00200, 00400, 00500 & 00600 which are coded by color
- Recycled Content: 48% by material weight



ITEM NO.	ID NO. 83086 UPC	COLOR	CTN WT LBS	CTN CUBE	CTN QTY	MIN ORD QTY	U O M
½" CAPACITY, 8½" X 11" SHEET SIZE (W X H)							
00100	00100 0	Assorted	9.1	0.7	12	12	EA
00101	00101 7	Black	9.1	0.7	12	12	EA
00102	00102 4	Blue	9.1	0.7	12	12	EA
00104	00104 8	White	9.1	0.7	12	12	EA
00105	00105 5	Green	9.1	0.7	12	12	EA
00107	00107 9	Red	9.1	0.7	12	12	EA
00137	00137 6	Gray	9.1	0.7	12	12	EA
00147	00147 5	Navy	9.1	0.7	12	12	EA
00157	00157 4	Maroon	9.1	0.7	12	12	EA
00174	00174 1	Assorted	8.0	0.6	10	10	EA

1" CAPACITY, 8½" X 11" SHEET SIZE (W X H)

00200	00200 7	Assorted	9.6	0.9	12	12	EA
00201	00201 4	Black	9.6	0.9	12	12	EA
00202	00202 1	Blue	9.6	0.9	12	12	EA
00204	00204 5	White	9.6	0.9	12	12	EA
00205	00205 2	Green	9.6	0.9	12	12	EA
00207	00207 6	Red	9.6	0.9	12	12	EA
00237	00237 3	Gray	9.6	0.9	12	12	EA
00247	00247 2	Navy	9.6	0.9	12	12	EA
00257	00257 1	Maroon	9.6	0.9	12	12	EA
00274	00274 8	Assorted	9.6	0.9	12	12	EA

1½" CAPACITY, 8½" X 11" SHEET SIZE (W X H)

00400	00400 1	Assorted	10.3	1.2	12	12	EA
00401	00401 8	Black	10.3	1.2	12	12	EA
00402	00402 5	Blue	10.3	1.2	12	12	EA
00404	00404 9	White	10.3	1.2	12	12	EA
00405	00405 6	Green	10.3	1.2	12	12	EA
00407	00407 0	Red	10.3	1.2	12	12	EA
00437	00437 7	Gray	10.3	1.2	12	12	EA
00447	00447 6	Navy	10.3	1.2	12	12	EA
00457	00457 5	Maroon	10.3	1.2	12	12	EA
00474	00474 2	Assorted	10.3	1.2	12	12	EA

(continued on next column)

BASIC VALUE® ROUNDING BINDERS (CONTINUED)

ITEM NO.	ID NO. 83086 UPC	COLOR	CTN WT LBS	CTN CUBE	CTN QTY	MIN ORD QTY	U O M
2" CAPACITY, 8½" X 11" SHEET SIZE (W X H)							
00500	00500 8	Assorted	13.9	1.7	12	12	EA
00501	00501 5	Black	13.9	1.7	12	12	EA
00502	00502 2	Blue	13.9	1.7	12	12	EA
00504	00504 6	White	13.9	1.7	12	12	EA
00505	00505 3	Green	13.9	1.7	12	12	EA
00507	00507 7	Red	13.9	1.7	12	12	EA
00537	00537 4	Gray	13.9	1.7	12	12	EA
00547	00547 3	Navy	13.9	1.7	12	12	EA
00557	00557 2	Maroon	13.9	1.7	12	12	EA
00576	00576 3	Assorted	7.0	0.8	6	6	EA

3" CAPACITY, 8½" X 11" SHEET SIZE (W X H)

00600	00600 5	Assorted	17.8	2.1	12	12	EA
00601	00601 2	Black	17.8	2.1	12	12	EA
00602	00602 9	Blue	17.8	2.1	12	12	EA
00604	00604 3	White	17.8	2.1	12	12	EA
00605	00605 0	Green	17.8	2.1	12	12	EA
00607	00607 4	Red	17.8	2.1	12	12	EA
00637	00637 1	Gray	17.8	2.1	12	12	EA
00647	00647 0	Navy	17.8	2.1	12	12	EA
00657	00657 9	Maroon	17.8	2.1	12	12	EA

BINDERS W/LABEL HOLDER, 8½" X 11" SHEET SIZE (W X H)

00291E	00291 5	1", Black	10.8	0.9	12	12	EA
00491E	00491 9	1½", Black	11.8	1.2	12	12	EA
00591E	00591 6	2", Black	15.8	1.7	12	12	EA
00691E	00691 3	3", Black	19.2	2.1	12	12	EA
00699	00699 9	3", Assorted	6.0	0.7	4	4	EA

ECONOMYVALUE™ ROUNDING BINDERS

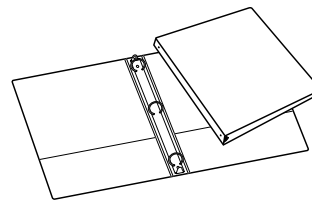

- MicroFine™ Suede Finish vinyl cover material
- Dual opening and closing ring metal triggers
- Horizontal clear vinyl pocket inside front and back covers
- Assorted packs have same UPC code on each product in pack
- Recycled Content: 45% by material weight



ITEM NO.	ID NO. 83086 UPC	COLOR	CTN WT LBS	CTN CUBE	CTN QTY	MIN ORD QTY	U O M
1" CAPACITY, 8½" X 11" SHEET SIZE (W X H)							
03010	03010 9	Assorted	9.3	0.9	12	12	EA
1½" CAPACITY, 8½" X 11" SHEET SIZE (W X H)							
03050	03050 5	Assorted	10.4	1.2	12	12	EA
2" CAPACITY, 8½" X 11" SHEET SIZE (W X H)							
03020	03020 8	Assorted	12.8	1.7	12	12	EA



SPECIALTY PURPOSE BINDERS

EASYOPEN® CLEARVUE™ COLLECTOR'S BINDERS

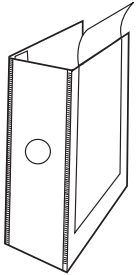

- Opens and closes with just the touch of one finger
- "Ease-of-Use" Commendation from Arthritis Foundation
- Safer and easier to use than any other ring metal
- Finger pull hole for easy shelf removal
- Great for coins, cards, stamps and presentations.
- Recycled content 44% by material weight



ITEM NO.	ID NO. 83086 UPC	COLOR	CTN WT LBS	CTN CUBE	CTN QTY	MIN ORD QTY	U O M
3" CAPACITY, 8½" X 11" SHEET SIZE (W X H)							
18901	18901 2	Black	8.5	1.4	4	4	EA

SLANT-D® LEGAL SIZE BINDERS



- Legal size vinyl binder
- Clear label holder on spine
- Available with standard 3 or 4-ring non-locking D-ring metal
- Stands up to years of use with XtraLife® Hinge and BlindEdge™ Weld
- Poly sheet lifter helps guide large size papers over rings
- Recycled Content: 43% by material weight



ITEM NO.	ID NO. 83086 UPC	COLOR	CTN WT LBS	CTN CUBE	CTN QTY	MIN ORD QTY	U O M
3 RING, 1" CAPACITY, 8½" X 14" SHEET SIZE (W X H)							
14232	14232 1	Black, 3 Ring: 4½" C to C	9.8	0.5	6	6	EA
3 RING, 2" CAPACITY, 8½" X 14" SHEET SIZE (W X H)							
14532	14532 2	Black, 3 Ring: 4½" C to C	11.8	0.9	6	6	EA
4 RING, 2" CAPACITY, 8½" X 14" SHEET SIZE (W X H)							
14632	14632 9	Black, 4 Ring: 3½" C to C	11.8	0.9	6	6	EA

MINI PREMIUM ROUNDING BINDERS

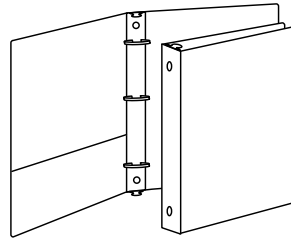

- Smooth suedene vinyl covers
- Horizontal pocket inside front
- Dual opening ring metal triggers
- Heavy weight covers, Xtralife® Hinge and BlindEdge™ Weld for extended use
- Two sheet sizes: 5½"x8½" and 6"x9½"
- Recycled Content: 47% by material weight



ITEM NO.	ID NO. 83086 UPC	COLOR	CTN WT LBS	CTN CUBE	CTN QTY	MIN ORD QTY	U O M
1" CAPACITY, 6"x9½" SHEET SIZE (W X H)							
06201	06201 8	Black: 3½" C to C	8.7	0.6	12	12	EA
1" CAPACITY, 5½"x8½" SHEET SIZE (W X H)							
07201	07201 7	Black: 2¾" C to C	7.9	0.5	12	12	EA
07202	07202 4	Blue: 2¾" C to C	7.9	0.5	12	12	EA
07299	07299 4	Assorted: 2¾" C to C	7.9	0.5	12	12	EA

MINI CLEARVUE™ ROUNDING BINDER

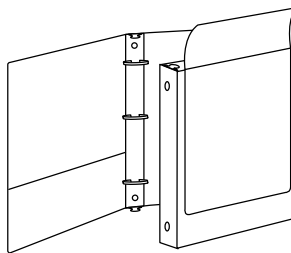

- Clear overlays on front, back and spine allows insertion of custom title sheets
- Horizontal pocket inside front
- Dual opening and closing ring metal triggers
- Heavy vinyl weight covers, Xtralife® Hinge for extended use
- Recycled Content: 31% by material weight



ITEM NO.	ID NO. 83086 UPC	COLOR	CTN WT LBS	CTN CUBE	CTN QTY	MIN ORD QTY	U O M
1" CAPACITY, 5½" X 8½" SHEET SIZE (W X H)							
07100	07100 3	White: 2¾" C to C	7.7	0.5	12	12	EA

SCHOOL BINDERS

EASYOPEN® PROFILE BINDERS

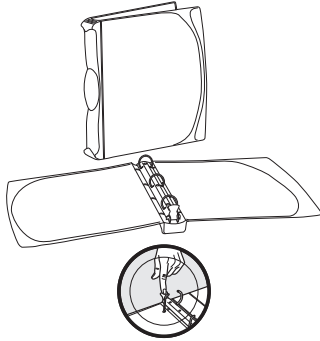

- Significantly easier to open and close requiring only one finger
- Archival-safe for all documents and photos - will not lift or transfer inks or toners
- Unique design offers an easy-grip cover and a stable writing surface when opened out flat
- "Ease of Use" Commendation from the Arthritis Foundation
- Safer to operate (will not pinch fingers or cause injury when closing)
- Security of a positive lock when closed
- Trigger will not scratch work surface
- Translucent frost clear cover
- Label holder/lens cover in assorted colors (blue, green, red and clear)
- FREE software templates from www.cardinalbrands.com/support



ITEM NO.	ID NO. 83086 UPC	COLOR	CTN WT LBS	CTN CUBE	CTN QTY	MIN ORD QTY	U O M
----------	---------------------	-------	------------	----------	---------	-------------	-------

ROUND RING 1" CAPACITY, 8½" X 11" SHEET SIZE (W X H)

14410	14410 3	Frost Clear	10.1	1.0	8	8	EA
14410M	01410 9	Clear/Asst PDQ	10.0	1.2	8	8	EA
14411	14411 0	Black	10.1	1.0	8	8	EA
14412	14412 7	Dark Blue	10.1	1.0	8	8	EA
14413	14413 4	Clear/Clear	10.1	1.0	8	8	EA
14415	14415 8	Clear/Blue	10.1	1.0	8	8	EA

D-RING 1½" CAPACITY, 8½" X 11" SHEET SIZE (W X H)

14440	14440 0	Frost Clear	8.7	1.0	6	6	EA
14441	14441 7	Black	8.7	1.0	6	6	EA
14442	14442 4	Dark Blue	8.7	1.0	6	6	EA
14443	14443 1	Clear/Clear	8.7	1.0	6	6	EA
14445	14445 5	Clear/Blue	8.7	1.0	6	6	EA

POCKETS 4 KEEPS BINDER

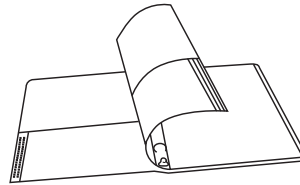

- Double cover construction creates twin pocket portfolios in front and back of binders (patent protected)
- Archival-safe for all documents and photos - will not lift or transfer inks or toners
- Separate portfolio saves ring space, provides ample storage space for loose materials
- Contrasting inside and outside colors
- Durable poly cover material
- 1" round ring metal has dual opening and closing triggers
- Assorted translucent colors
- All assorted packs have common UPC bar code

U.S. Patent



ITEM NO.	ID NO. 83086 UPC	COLOR	CTN WT LBS	CTN CUBE	CTN QTY	MIN ORD QTY	U O M
84014	84014 2	Assorted Colors PDQ	8.0	0.9	12	12	EA

HIP POCKET RING BINDER

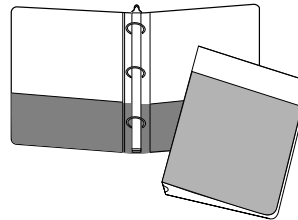

- Features 9" tall outside pockets on front and back cover, made in contrasting color vinyl
- Horizontal pockets inside front and back also made in contrasting color vinyl
- Dual opening and closing round ring metal triggers
- Ideal for school use
- Recycled Content: 43% by material weight



ITEM NO.	ID NO. 83086 UPC	COLOR	CTN WT LBS	CTN CUBE	CTN QTY	MIN ORD QTY	U O M
09298	09298 5	Assorted Colors	5.3	0.5	6	6	EA

1½" CAPACITY, 8½" X 11" SHEET SIZE (W X H)

09498	09498 9	Assorted Colors	5.9	0.7	6	6	EA
-------	---------	-----------------	-----	-----	---	---	----



POLY BINDERS

POLY SPINEVUE® BINDERS

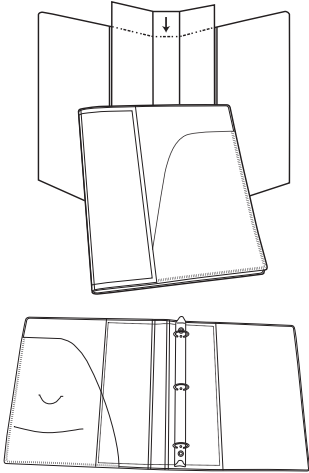

- Exclusive wrap-around clear overlay holds standard letter size sheets
- Archival-safe for all documents and photos - will not lift or transfer inks or toners
- Save time – easy to customize for presentations or filing – no trimming or fumbling with small spine inserts and separate cover inserts as needed for standard overlay binders
- Download FREE software templates from www.cardinalbrands.com/support
- Frosty translucent poly material is strong and heavyweight
- Slanted document pocket on inside front with die-cut slot for a CD and security tab
- Durable 1" round ring metal with boosters



ITEM NO.	ID NO. 83086 UPC	COLOR	CTN WT LBS	CTN CUBE	CTN QTY	MIN ORD QTY	U O M
1" CAPACITY, 8½" X 11" SHEET SIZE (W X H)							
18115	18115 3	Translucent PDQ	5.8	0.8	12	12	EA

COVERLOCK™ BINDER WITH REMOVABLE FOLDER

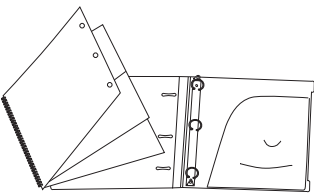

- Cover snaps over rings to secure contents
- Removable 4 pocket folder
- Back pocket with CD die cut
- Archival-safe for all documents and photos - will not lift or transfer inks or toners
- Holds 240 sheets
- Assorted colors: cranberry, amber, blue and green



ITEM NO.	ID NO. 83086 UPC	COLOR	CTN WT LBS	CTN CUBE	CTN QTY	MIN ORD QTY	U O M
1" CAPACITY, 8½" X 11" SHEET SIZE (W X H)							
84066	84066 1	Assorted PDQ	8.0	0.9	12	12	EA

POLYTEX™ RECYCLED BINDERS



- Uniquely textured polyethylene covers are made from recycled milk jugs
- Archival-safe for all documents and photos - will not lift or transfer inks or toners
- Minimum 90% post-consumer waste
- Extra strong heavy gauge poly is impervious to temperature and moisture, will not crack or split
- Deep rich color is saturated throughout
- Round ring metal with dual opening and closing triggers
- Suitable for dust-free work environments
- Recycled Content: 58% by material weight
- All colors in POLYtex™ assorted packs have same UPC#



ITEM NO.	ID NO. 83086 UPC	COLOR	CTN WT LBS	CTN CUBE	CTN QTY	MIN ORD QTY	U O M
½" CAPACITY, 8½" X 11" SHEET SIZE (W X H)							
41212	41212 7	Assorted PDQ	5.1	0.5	12	12	EA
1" CAPACITY, 8½" X 11" SHEET SIZE (W X H)							
41211	41211 0	Assorted PDQ	5.9	0.7	12	12	EA

POWER™ POLY BINDERS

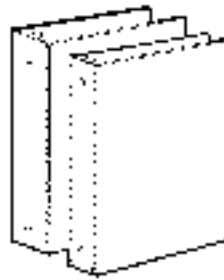

- Heavy and medium gauge polypropylene covers will not crack or split
- Textured cover resists scratches
- Round ring metal with dual opening and closing triggers
- Archival-safe for all documents and photos - will not lift or transfer inks or toners
- Suitable for dust-free work environments; Ideal for business or school
- All assorted packs have common UPC number on products in pack and come in stadium carton display



ITEM NO.	ID NO. 83086 UPC	COLOR	CTN WT LBS	CTN CUBE	CTN QTY	MIN ORD QTY	U O M
HEAVY WEIGHT, 1" CAPACITY, 8½" X 11" SHEET SIZE (W X H)							
41200	41200 4	Assorted Basic Colors PDQ	6.2	0.8	12	12	EA
MEDIUM WEIGHT, ½" CAPACITY, 8½" X 11" SHEET SIZE (W X H)							
42100	42100 6	Assorted Basic Colors PDQ	4.2	0.5	12	12	EA
42199	42199 0	Assorted Fashion Shades PDQ	4.3	0.5	12	12	EA
MEDIUM WEIGHT, 1" CAPACITY, 8½" X 11" SHEET SIZE (W X H)							
41199	41199 1	Assorted Fashion Shades PDQ	5.1	0.7	12	12	EA
42200	42200 3	Assorted Basic Colors PDQ	4.6	0.7	12	12	EA

POLY BINDERS

DURAPOLY™ BINDERS

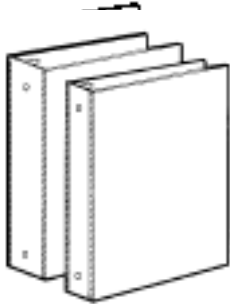

- Durable polypropylene covers will not crack or split
- Archival-safe for all documents and photos – will not lift or transfer inks or toners
- Bends and flexes, but returns to original shape
- Round ring metal with dual opening and closing triggers
- Suitable for dust-free work environments; Ideal for school use
- All assorted packs have common UPC bar code and come in stadium cartons



ITEM NO.	ID NO. 83086 UPC	COLOR	CTN WT LBS	CTN CUBE	CTN QTY	MIN ORD QTY	U O M
½" CAPACITY, 8½" X 11" SHEET SIZE (W X H)							
40180	40180 0	Assorted Colors PDQ	4.3	0.6	12	12	EA
1" CAPACITY, 8½" X 11" SHEET SIZE (W X H)							
40280	40280 7	Assorted Colors PDQ	5.5	0.8	12	12	EA

COLORVUE™ POLY BINDERS

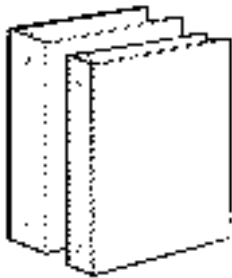

- Durable polypropylene covers will not crack or split
- Archival-safe for all documents and photos – will not lift or transfer inks or toners
- Translucent colors with brilliant embossing
- Round ring metal with dual opening and closing triggers
- All assorted packs have common UPC bar code and come in stadium cartons



ITEM NO.	ID NO. 83086 UPC	COLOR	CTN WT LBS	CTN CUBE	CTN QTY	MIN ORD QTY	U O M
1" CAPACITY, 8½" X 11" SHEET SIZE (W X H)							
40185	40185 5	Assorted Colors PDQ	5.4	0.7	12	12	EA
40182	40182 4	Blue	5.2	0.7	12	12	EA
40184	40184 8	Green	5.2	0.7	12	12	EA
40186	40186 2	Purple	5.2	0.7	12	12	EA
40187	40187 9	Red	5.2	0.7	12	12	EA

BINDER INDEXES & POCKETS

ONESTEP® INDEX SYSTEM

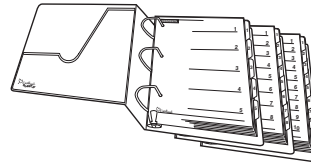

- Create custom index in minutes, no tab typing or inserting necessary
- Suitable for laser or inkjet printers, as well as standard typewriters
- Mylar® reinforced tabs and Content Sheet
- ReproMaster® Sheet included is designed to easily create multiple sets of indexes using photo copier
- Available with numbered, alphabetical and monthly tabbed sets
- Available with all clear (white) tabs or multi-color tabs
- FREE software templates available at www.cardinalbrands.com/support

ITEM NO.	ID NO. 83086 UPC	DESCRIPTION	CTN WT LBS	CTN CUBE	CTN QTY	MIN ORD QTY	U O M
8½" X 11" SHEET SIZE (W X H)							
60513	60513 0	5 Tab, Clear	25.3	0.9	144	24	EA
60518	60518 5	5 Tab, Multi-Color	25.3	0.9	144	24	EA
60813	60813 1	8 Tab, Clear	35.4	1.3	144	24	EA
60818	60818 6	8 Tab, Multi-Color	35.4	1.3	144	24	EA
61013	61013 4	10 Tab, Clear	42.1	1.3	144	24	EA
61018	61018 9	10 Tab, Multi-Color	42.1	1.3	144	24	EA
61213	61213 8	12 Tab, Clear	47.6	1.8	144	24	EA
61218	61218 3	12 Tab, Multi-Color	47.6	1.8	144	24	EA
61513	61513 9	15 Tab, Clear	56.8	1.8	144	24	EA
61518	61518 4	15 Tab, Multi-Color	56.8	1.8	144	24	EA
60113	60113 2	1-31, Clear	56.9	1.8	72	12	EA
60118	60118 7	1-31, Multi-Color	56.9	1.8	72	12	EA
60213	60213 9	A- Z, Clear	48.6	1.8	72	12	EA
60218	60218 4	A- Z, Multi-Color	48.6	1.8	72	12	EA
60313	60313 6	Monthly, Clear	49.0	1.8	144	24	EA
60318	60318 1	Monthly, Multi-Color	49.0	1.8	144	24	EA

ONESTEP® PLUS INDEX SYSTEM



- Extra width of dividers is designed to use with top loading sheet protectors or collector pages like cards, coins, stamps, etc
- Suitable for laser or inkjet printers, as well as standard typewriters
- Mylar® reinforced tabs and Content Sheet
- ReproMaster® Sheet included is designed to easily create multiple sets of indexes using photo copier
- FREE software templates available at www.cardinalbrands.com/support

ITEM NO.	ID NO. 83086 UPC	DESCRIPTION	CTN WT LBS	CTN CUBE	CTN QTY	MIN ORD QTY	U O M
9½" X 11" SHEET SIZE (W X H)							
61313	61313 5	5 Tab, Clear	25.0	1.8	144	24	EA
61318	61318 0	5 Tab, Multi	25.0	1.8	144	24	EA
61613	61613 6	10 Tab, Clear	22.7	0.8	72	24	EA
61618	61618 1	10 Tab, Multi	22.7	0.8	72	24	EA
61813	61813 0	8 Tab, Clear	18.9	0.8	72	24	EA
61818	61818 0	8 Tab, Multi	18.9	0.8	72	24	EA



BINDER INDEXES AND POCKETS

ONESTEP® MORE INDEX SYSTEM

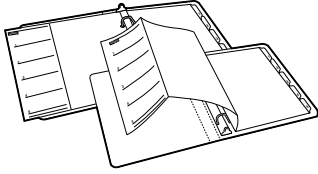

- Fold-out Table of Contents sheet keeps content information visible even when binder is open and in use
- Each set also includes regular style Content Sheet for optional use
- Available with all clear (white) tabs and multi-color tabs
- Suitable for laser or inkjet printers, as well as standard typewriters
- Mylar® reinforced tabs and Content Sheet
- ReproMaster® Sheet included is designed to easily create multiple sets of indexes using photo copier
- FREE software templates available at www.cardinalbrands.com/support

U.S. Patent #5,299,879

ITEM NO.	ID NO. 83086 UPC	DESCRIPTION	CTN WT LBS	CTN CUBE	CTN QTY	MIN QTY	U ORD M
8½" X 11" SHEET SIZE (W X H)							
67513	67513 3	5 Tab, Clear	31.6	1.2	144	24	EA
67518	67518 8	5 Tab, Multi-Color	31.6	1.2	144	24	EA
67813	67813 4	8 Tab, Clear	42.0	1.8	144	24	EA
67818	67818 9	8 Tab, Multi-Color	42.0	1.8	144	24	EA
67013	67013 8	10 Tab, Clear	48.8	1.8	144	24	EA
67018	67018 3	10 Tab, Multi-Color	48.8	1.8	144	24	EA
67213	67213 2	12 Tab, Clear	52.8	1.8	144	24	EA
67218	67218 7	12 Tab, Multi-Color	52.8	1.8	144	24	EA
67313	67313 9	15 Tab, Clear	64.1	2.0	144	24	EA
67318	67318 4	15 Tab, Multi-Color	64.1	2.0	144	24	EA

ONESTEP® PRO INDEX SETS

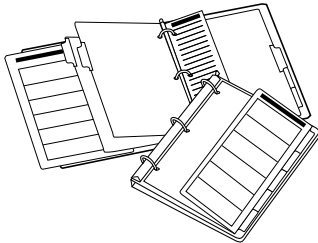

- Fold-out Contents page keeps titles visible while binder is in use
- One piece Content page construction requires no assembly
- Type title information once on ReproMaster® using laser printer, inkjet printer, or typewriter
- Create multiple sets fast by using 11x17" tray on copier (works with copiers or printers with 11x17" paper tray or feed)
- Preprinted multi-colored numerical tabs are Mylar® reinforced
- Convenient NoteStrip™ can be used anywhere in binder
- Includes regular style (8½x11") Content sheet for optional use
- FREE software templates available at www.cardinalbrands.com/support

U.S. Patent #5,299,879

ITEM NO.	ID NO. 83086 UPC	DESCRIPTION	CTN WT LBS	CTN CUBE	CTN QTY	MIN QTY	U ORD M
8½" X 11" SHEET SIZE (W X H)							
68508	68508 8	5 Tab, Multi-Color	31.6	1.3	144	24	EA
68808	68808 9	8 Tab, Multi-Color	42.0	1.8	144	24	EA
68008	68008 3	10 Tab, Multi-Color	48.8	1.8	144	24	EA
68208	68208 7	12 Tab, Multi-Color	52.8	1.8	24	24	EA
68308	68308 4	15 Tab, Multi-Color	64.1	1.8	24	24	EA

QUICKSTEP™ INDEX SYSTEM (BULK)



- Uncollated bulk pack of OneStep® and OneStep® More Indexes saves time and money
- Each carton includes enough product to create 24 index sets
- 6 extra Contents Sheets included with each box to accommodate last minute alterations
- Suitable for laser or inkjet printers, as well as standard typewriters
- Multiple sets can be made fast using office copier
- FREE software templates available at www.cardinalbrands.com/support

ITEM NO.	ID NO. 83086 UPC	DESCRIPTION	CTN WT LBS	CTN CUBE	CTN QTY	MIN QTY	U ORD M
QUICKSTEP ONESTEP INDEX, 8½" X 11" SHEET SIZE (W X H)							
60533	60533 8	5 Tab, White	23.8	0.9	6	1	BX
60538	60538 3	5 Tab, Multi-Color	23.8	0.9	6	1	BX
60833	60833 9	8 Tab, White	34.0	1.3	6	1	BX
60838	60838 4	8 Tab, Multi-Color	36.4	1.3	6	1	BX
61033	61033 2	10 Tab, White	42.0	1.3	6	1	BX
61038	61038 7	10 Tab, Multi-Color	36.4	1.3	6	1	BX

ITEM NO.	ID NO. 83086 UPC	DESCRIPTION	CTN WT LBS	CTN CUBE	CTN QTY	MIN QTY	U ORD M
QUICKSTEP ONESTEP MORE INDEX, 8½" X 11" SHEET SIZE (W X H)							
67533	67533 1	5 Tab, White	27.9	1.2	6	1	BX
67538	67538 6	5 Tab, Multi-Color	27.9	1.2	6	1	BX
67833	67833 2	8 Tab, White	39.0	1.3	6	1	BX
67838	67838 7	8 Tab, Multi-Color	39.6	1.3	6	1	BX
67033	67033 6	10 Tab, White	39.0	1.8	6	1	BX
67038	67038 1	10 Tab, Multi-Color	46.4	1.8	6	1	BX

ONESTEP® POCKET INDEX SYSTEM

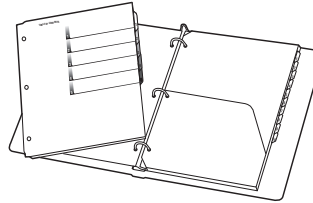

- Pocket on each divider holds 8½x11" sheets
- Use with laser printer, inkjet printer or typewriter
- Create titles on single Contents page or ReproMaster®
- Produce multiple sets fast with copier or printer
- Mylar® reinforced tabs and content sheet
- Multi-colored Contents sheet
- FREE software templates available at www.cardinalbrands.com/support

U.S. Patent #5,909,979

ITEM NO.	ID NO. 83086 UPC	DESCRIPTION	CTN WT LBS	CTN CUBE	CTN QTY	MIN QTY	U ORD M
8½" X 11" SHEET SIZE (W X H)							
68518	68518 7	5 Tab, Multi-Color	18.2	1.2	72	24	EA
68818	68818 8	8 Tab, Multi-Color	26.9	1.2	72	24	EA
68018	68018 2	10 Tab, Multi-Color	32.6	1.7	72	24	EA
68218	68218 6	12 Tab, Multi-Color	37.8	1.7	72	24	EA

BINDER INDEXES AND POCKETS

WRITE 'N ERASE® POCKET DIVIDERS

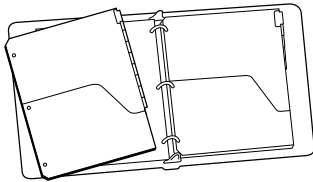

- Convenient pocket on each divider for letter size sheets
- Pocket profile shape provides easy access, maximum security
- Tab coated for use with any non-permanent pen, marker or pencil
- Erase and reuse, again and again
- Sheet size 8½" x 11"
- Available in 5 and 8 tab sets

ITEM NO.	ID NO. 83086		DESCRIPTION	CTN WT LBS	CTN CUBE	CTN QTY	MIN ORD QTY	U O M
	UPC							
8½" X 11" SHEET SIZE (W X H)								
60500	60500	0	5 Tab, White	18.2	1.2	72	24	EA
60508	60508	6	8 Tab, White	26.9	1.2	72	24	EA

DOUBLE POCKET DIVIDERS

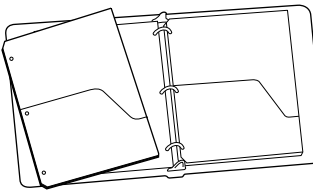

- Store documents up to 8½" x 11"
- Heavyweight construction
- White color coordinates with other pre-printed index tab sets
- Ideal for presentation handouts, organizing and quick reference
- High profile pocket shape provides both easy access and maximum security for contents

ITEM NO.	ID NO. 83086		DESCRIPTION	CTN WT LBS	CTN CUBE	CTN QTY	MIN ORD QTY	U O M
	UPC							
8½" X 11" SHEET SIZE (W X H)								
60155	60155	2	5/Pack, White	37.8	1.2	96	24	EA

POLY RING BINDER POCKETS

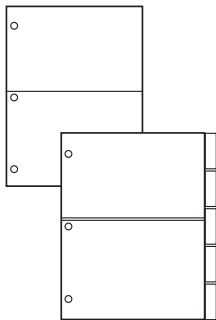

- Extra tough poly pockets outperform regular paper pockets for binders
- Will not fray or tear
- Archival-safe for all documents and photos - will not lift or transfer inks or toners
- Available in clear or multi-colored with insertable tabs, and multi-colored without-tabs
- Set of paper tab inserts included with insertable tab styles
- One set of 5 pocket pages per pack
- Pocket on both front and back of each page

ITEM NO.	ID NO. 83086		DESCRIPTION	PRODUCT DIMENSION	CTN WT LBS	CTN CUBE	CTN QTY	MIN ORD QTY	U O M
	UPC								
8½" X 11" SHEET SIZE (W X H)									
84007	84007	4	Multi-Color	11x8¾"	9.9	0.2	24	24	PK
9" X 11" SHEET SIZE (W X H)									
84009	84009	8	With Insertable Tabs, Multi-Color	11x9"	11.5	0.2	24	24	PK
84010	84010	4	With Insertable Tabs, Clear	11x9"	11.5	0.2	24	24	PK

EZY INDEX® INSERTABLE INDEX

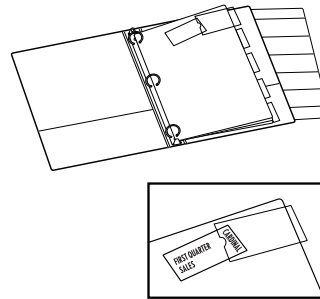

- Easy to create and assemble large size insertable tabs
- Large multi-color tab inserts provide ample room for tab titles plus
- Multiple tab sets can be produced fast using copier or printer. Laser/inkjet compatible
- Tab inserts will not slide out like those in traditional insertable dividers
- Durable poly will not damage photos, laser printed papers or photocopies
- FREE software templates available at www.cardinalbrands.com/support

U.S. Patent #5,875,579

ITEM NO.	ID NO. 83086		DESCRIPTION	CTN WT LBS	CTN CUBE	CTN QTY	MIN ORD QTY	U O M
	UPC							
8½" X 11" SHEET SIZE (W X H)								
61357	61357	9	5 Tab	4.3	0.1	24	24	EA
61387	61387	6	8 Tab	6.5	0.2	24	24	EA

WRITE 'N ERASE® TAB DIVIDERS

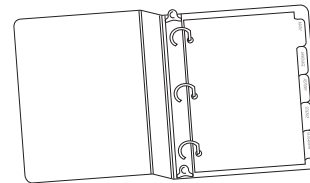

- Special Mylar® tabs allow use of any pen, pencil or non-permanent marker, erase clean and reuse again
- Instant index tabs; No time consuming tab typing or insertion
- Available in multi-color or white tabs

ITEM NO.	ID NO. 83086		DESCRIPTION	CTN WT LBS	CTN CUBE	CTN QTY	MIN ORD QTY	U O M
	UPC							
8½" X 11" SHEET SIZE (W X H)								
60506	60506	2	5 Tab, White	21.4	0.9	144	24	EA
60509	60509	3	5 Tab, Multi-Color	21.4	0.9	144	24	EA
60806	60806	3	8 Tab, White	30.5	1.3	144	24	EA
60808	60808	7	8 Tab, Multi-Color	20.8	1.4	144	24	EA



BINDER ACCESSORIES

SHEET LIFTERS



- Makes closing a full binder easier
- Facilitates easy movement of sheets over rings, reduces sheet wear
- Bulk packed order quantity

ITEM NO.	DESCRIPTION	PRODUCT DIMENSION	CTN QTY	MIN ORD QTY	U O M
SL080	Flat Sheetlifter	3x11"	1	1	EA
SL090	Flat Sheetlifter	5x11"	1	1	EA
SL311	Curved Sheetlifter (for 2" and Up)	2½x10½"	1	1	EA
SL670	Flat Sheetlifter	8½x11"	1	1	EA

PRESENTATION BOOKS & REPORT COVERS

CUSTOM SHOWFILE™ DISPLAY BOOKS

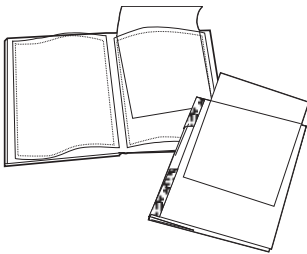

- Bound books with top-loading, clear poly protector pockets
- Non-transfer pocket material will not lift ink from pages or damage photographs
- Custom Showfile™ Books have clear overlay on front cover for custom inserts
- Back pocket for loose papers is die-cut for business card
- Durable poly covers
- FREE software templates available at www.cardinalbrands.com/support

ITEM NO.	ID NO. 83086 UPC	DESCRIPTION	CTN WT LBS	CTN CUBE	CTN QTY	MIN ORD QTY	U O M
8½" X 11" SHEET SIZE (W X H)							
50032	50032 9	Black, 6 Pockets PDQ	26.3	1.5	72	12	EA
50037	50037 4	White, 6 Pockets PDQ	26.3	1.5	72	12	EA
50132	50132 6	Black, 12 Pockets PDQ	5.4	0.2	12	12	EA
50138	50138 8	White, 12 Pockets PDQ	5.4	0.2	12	12	EA
50232	50232 3	Black, 24 Pockets PDQ	8.7	0.4	12	12	EA
50140	50140 1	White, 24 Pockets PDQ	8.7	0.4	12	12	EA

PRESENTATION BOOKS & REPORT COVERS

SPINEVUE® SHOWFILE™ DISPLAY BOOKS

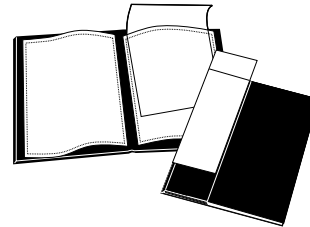
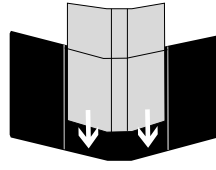

- Bound books with top-loading, clear poly protector pockets
- Non-transfer pocket material will not lift ink from pages or damage photographs
- SpineVue® Showfile™ books have clear overlay spines that hold an 8½x11" sheet, making it easy to customize front and back with single insert (Patent Protected)
- Back pocket for loose papers is die-cut for business card
- Durable poly covers
- FREE software templates available at www.cardinalbrands.com/support

U.S. Patent #5,720,564

ITEM NO.	ID NO. 83086 UPC	DESCRIPTION	CTN WT LBS	CTN CUBE	CTN QTY	MIN ORD QTY	U O M
8½" X 11" SHEET SIZE (W X H)							
51032	51032 8	Black, 6 Pockets PDQ	31.0	1.4	72	12	EA
51132	51132 5	Black, 12 Pockets PDQ	5.3	0.2	12	12	EA
51232	51232 2	Black, 24 Pockets PDQ	8.2	0.4	12	12	EA

SPINEVUE® SHOWFILE™ WITH INDEX

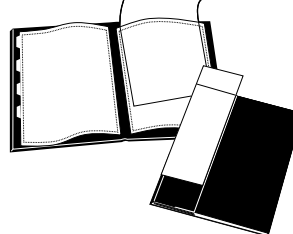
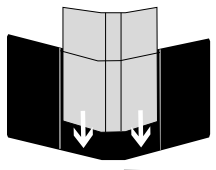

- Unique bound presentation book features 5 tab indexed dividers that can be repositioned anywhere in the book
- Cover features patent protected SpineVue® overlay that holds 8½x11" title sheet
- Download FREE software templates from www.cardinalbrands.com/support
- Non-transfer pocket material will not lift ink from pages or damage photographs
- Clear poly pages won't damage photos, copies or prints
- Contents sheet and tab labels included
- 24 pockets/48 display pages
- Black poly cover
- FREE software templates available at www.cardinalbrands.com/support

U.S. Patent #5,720,564

ITEM NO.	ID NO. 83086 UPC	DESCRIPTION	CTN WT LBS	CTN CUBE	CTN QTY	MIN ORD QTY	U O M
8½" X 11" SHEET SIZE (W X H)							
51336	51336 7	Black, 24 Pockets PDQ	9.9	0.4	12	12	EA

PRESENTATION BOOKS & REPORT COVERS

CLEARTHRU™ SHOWFILE

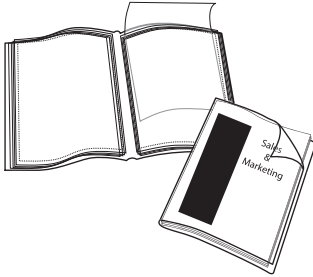

- Clear flexible poly cover adds brilliance to any photo or title page
- 12 Crystal clear pockets for up to 24 pages
- Bound book with top-loading, clear poly protector pockets
- Archival safe, non-transfer pocket material will not lift ink from pages or damage photos
- FREE software templates available at www.cardinalbrands.com/support

ITEM NO.	ID NO. 83086 UPC	COLOR	CTN WT LBS	CTN CUBE	CTN QTY	MIN ORD QTY	U O M
8½" X 11" SHEET SIZE (W X H)							
51532	51532 3	Clear, 12 Pocket	PDQ	6.0	0.2	24	24 EA

EASEL SHOWFILE™ DISPLAY BOOKS

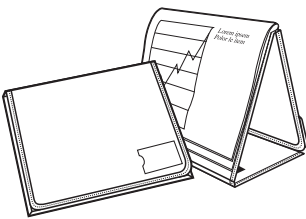

- Ideal for presentations, slim and light weight
- Non-transfer pocket material will not lift ink from pages or damage photographs
- Velcro® tabs secure Showfile™ open in standing position for use, and closed when stored
- Black poly cover w/stitched fabric edges
- Each book has 20 clear pockets for 40 display pages
- Clear business card pocket on outside front
- Available in vertical and horizontal letter size

ITEM NO.	ID NO. 83086 UPC	DESCRIPTION	CTN WT LBS	CTN CUBE	CTN QTY	MIN ORD QTY	U O M
VERTICAL 8½" X 11" SHEET SIZE (W X H)							
52111	52111 9	Letter, Portrait	PDQ	13.2	0.6	12	12 EA
HORIZONTAL 11" X 8½" SHEET SIZE (W X H)							
52132	52132 4	Letter, Landscape	PDQ	14.3	0.7	12	12 EA

NEW REPORTPRO™ PRESENT IT™ REPORT COVERS

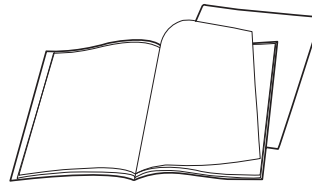

- Ultra slim— these covers are ideal for reports, presentations and reference
- Acid-free, non-stick, transfer safe poly is safe for photos, laser prints and photocopies
- Crystal clear bound-in, top-loading "sheet protector" style pages for protection and display of documents
- No hole punching or "brads" required and pages will open and lay flat
- Available in 6 pockets for up to 12 display pages or 12 pockets for up to 24 display pages

ITEM NO.	ID NO. 83086 UPC	COLOR	CTN WT LBS	CTN CUBE	CTN QTY	MIN ORD QTY	U O M
6 POCKET 8½" X 11" SHEET SIZE (W X H)							
13900	13900 0	Assorted	2.9	0.1	25	25	EA
13902	13902 4	Dark Blue	2.9	0.1	25	25	EA
12 POCKET 8½" X 11" SHEET SIZE (W X H)							
13910	13910 9	Assorted	4.3	0.1	25	25	EA
13912	13912 3	Dark Blue	4.3	0.1	25	25	EA

NEW REPORTPRO™ EXPANDING 2 POCKET PORTFOLIOS

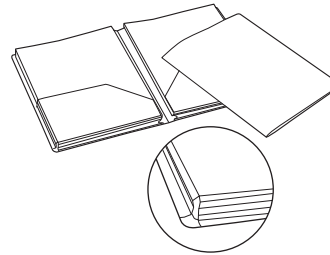

- The perfect file for big projects
- Each pocket expands to hold up to ½" of material—total 1" per portfolio
- Holds up to 200 standard letter-size sheets
- Acid-free, non-stick, transfer safe poly won't damage photos, copies or prints—safe for all documents
- Made of sturdy polypropylene in 6 assorted colors

ITEM NO.	ID NO. 83086 UPC	COLOR	CTN WT LBS	CTN CUBE	CTN QTY	MIN ORD QTY	U O M
8½" X 11" SHEET SIZE (W X H)							
13500	13500 2	Assorted	4.4	0.3	30	30	EA

REPORTPRO™ GLIDING™ REPORT COVER

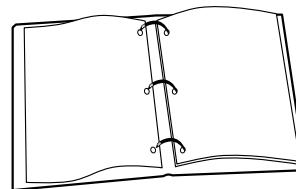

- Covers are extra wide for use with index or sheet protectors
- 50 Sheet capacity
- Opens completely so pages lie flat and stay open
- Secure ring closure will not accidentally open
- Easy to insert, add and remove pages
- Strong poly covers are non-stick, transfer safe for all documents and photos

U.S. Patent #4,784,507

ITEM NO.	ID NO. 83086 UPC	COLOR	CTN WT LBS	CTN CUBE	CTN QTY	MIN ORD QTY	U O M
8½" X 11" SHEET SIZE (W X H)							
22147	22147 7	Clear	21	1.9	150	25	EA



PRESENTATION BOOKS & REPORT COVERS

REPORTPRO™ GLIDERING™ HANGING REPORT COVER

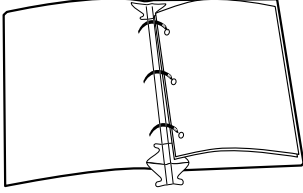

- Flip out hooks allow it to hang in standard letter size file drawer
- Opens completely so pages lie flat and stay open
- Secure ring closure will not accidentally open
- Includes slots for standard hanging index file tabs
- Easy to insert, add and remove pages
- Strong poly covers are non-stick, transfer safe for all documents and photos
- Holds up to 50 letter size sheets

U.S. Patent #4,784,507 & #5,593,184

ITEM NO.	ID NO.		CTN LBS	CTN CUBE	CTN QTY	MIN ORD QTY	U O M
	83086	UPC					
8½" X 11" SHEET SIZE (W X H)							
22167	22167	5	Clear	21	1.9	150	25 EA

REPORTPRO™ REPORT COVER WITH PIVOTGRIP™ CLOSURE

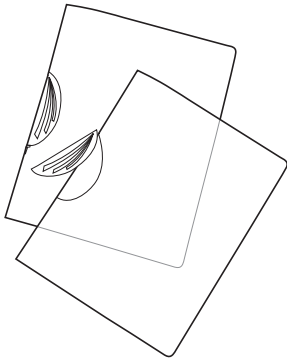

- No hole punching required
- Archival safe polypropylene material will not transfer print on the inside or outside covers
- Smooth, easy operation will not harm documents inside
- Frost clear cover
- PivotGrip closure is in 5 assorted colors: black, blue, red, green, yellow
- Holds standard 8½" x 11"
- 30 sheet capacity

ITEM NO.	ID NO.		CTN LBS	CTN CUBE	CTN QTY	MIN ORD QTY	U O M
	83086	UPC					
8½" X 11" SHEET SIZE (W X H)							
22020	22020	3	Frost Clear with Asst PivotGrip	PDQ	6.0	0.4	25 25 EA

NEW REPORTPRO™ PIVOTGRIP REPORT COVER WITH DOCUMENT POCKET

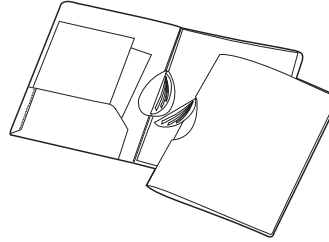

- Unique new report cover has an inside document pocket for brochures, photos and related materials
- PivotGrip operates smoothly and will not damage paper edges
- Acid-free, transfer safe poly won't lift print or damage photos and is safe for all documents
- Holds from 1 to 30 sheets in the PivotGrip plus up to another 20 sheets in the pocket
- Distinctive yet professional appearance, available in assorted color pack (Dark Blue, Dark Red, Light Blue, Green and Yellow) or in solid color packs including black

ITEM NO.	ID NO.		CTN LBS	CTN CUBE	CTN QTY	MIN ORD QTY	U O M
	83086	UPC					
8½" X 11" SHEET SIZE (W X H)							
13800	13800	3	Assorted	3.9	0.3	25	25 EA

REPORTPRO™ REPORT COVER WITH SLIDEGRIP™ CLOSURE

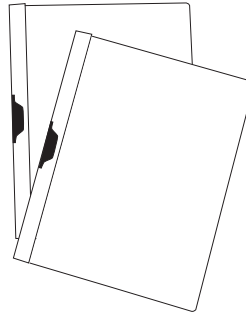

- No hole punching required
- Archival safe polypropylene material will not transfer print on the inside or outside covers
- Clear front cover
- Smooth, easy operation will not harm documents inside
- Assortment includes black, blue, dark blue, maroon and green
- Holds standard 8½" x 11"
- 30 sheet capacity

ITEM NO.	ID NO.		CTN LBS	CTN CUBE	CTN QTY	MIN ORD QTY	U O M
	83086	UPC					
8½" X 11" SHEET SIZE (W X H)							
22352	22352	5	Assorted	31.0	1.7	250	25 EA
2203 BLA	22003	6	Black	31.0	1.7	250	25 EA
2203 BLU	22033	3	Lt. Blue	31.0	1.7	250	25 EA
2203 DKB	22041	8	Dark Blue	31.0	1.7	250	25 EA
2203 GRE	22035	7	Green	31.0	1.7	250	25 EA
2203 MAR	22043	2	Maroon	31.0	1.7	250	25 EA
2203 RED	22036	4	Red	31.0	1.7	250	25 EA

PRESENTATION BOOKS & REPORT COVERS

SLIDELOCK REPORT COVERS

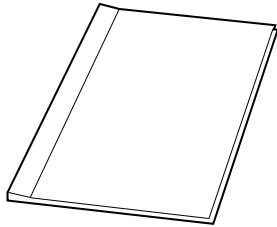

- Quick, economical report cover
- Insert pages in clear plastic cover
- Slide on binding spine strips
- No hole punching required
- Assorted colors

ITEM NO.	ID NO. 83086 UPC	DESCRIPTION	CTN WT LBS	CTN CUBE	CTN QTY	MIN ORD QTY	U O M
8½" X 11" SHEET SIZE (W X H)							
22633	22633 5	Assorted, 3/Pack	4.6	0.3	30	30	PK
22636	22636 6	Assorted, 6/Pack	4.6	0.3	15	15	PK

EIGHT POCKET PORTFOLIO

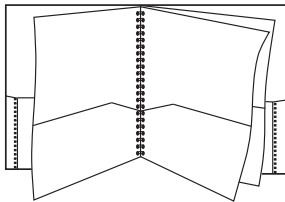

- Extra strong poly pocket portfolio resists tears and moisture
- Archival safe polypropylene material will not transfer print on the inside or outside covers
- Plastic comb binding secures transparent dividers with pocket on each side
- Eight full size pockets. Each holds up to 20- 8½x11" sheets
- Carton includes 3 assorted colors

ITEM NO.	ID NO. 83086 UPC	COLOR	CTN WT LBS	CTN CUBE	CTN QTY	MIN ORD QTY	U O M
8½" X 11" SHEET SIZE (W X H)							
84028	84028 9	Assorted	5.0	0.5	12	12	EA
84008	84008 1	Assorted PDQ	11.3	1.0	24	24	EA

NEW REPORTPRO™ 10 POCKET PROJECT ORGANIZER

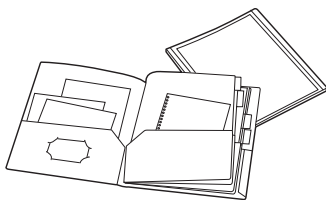

- Features 10 pockets and 4 insertable tab dividers with label holders to organize a big project or several small projects
- Acid-free, non-stick, transfer safe poly won't lift print or damage photos—safe for all documents
- View style front cover for easy customization using one letter size sheet
- Die cut on inside front cover for business card
- Holds up to 200 letter-size sheets

ITEM NO.	ID NO. 83086 UPC	COLOR	CTN WT LBS	CTN CUBE	CTN QTY	MIN ORD QTY	U O M
8½" X 11" SHEET SIZE (W X H)							
13600	13600 9	Assorted	10	0.8	24	24	EA

HOLDit!® LABELING & PRESENTATION ACCESSORIES

NEW HOLDit!® PROJECT POCKETS

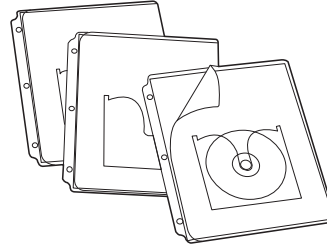

- Keeps and protects your CD/DVD or data disk with your hard copy
- Pockets are 3 hole punched to fit any standard binder
- Acid-free, transfer safe poly won't damage photos, copies or prints – safe for all documents
- Made of sturdy polypropylene
- 1 set of 3 per pack, assorted colors for easy organization

ITEM NO.	ID NO. 83086 UPC	DESCRIPTION	CTN WT LBS	CTN CUBE	CTN QTY	MIN ORD QTY	U O M
13700	13700 6	Assorted	4.4	0.2	24	24	PK

HOLDit!® CD POCKET

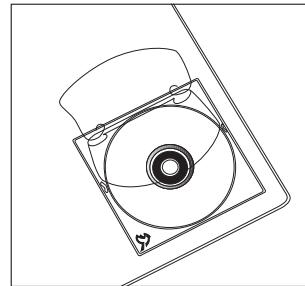

- Ideal for presentations, electronic catalogs, interactive sales materials, data filing, etc.
- Special retainers on each side prevent CD from sliding out
- Protective flap covers entire CD
- High quality clear vinyl with self-adhesive backing that is formulated to be compatible with all material surfaces, including PVC vinyl (ring binders and pad holders). Will not "weep" or become "gummy".
- Packed 10 per poly bag in display carton

ITEM NO.	ID NO. 83086 UPC	DESCRIPTION	PRODUCT DIMENSION	CTN WT LBS	CTN CUBE	CTN QTY	MIN ORD QTY	U O M
21845	21845 3	CD Pocket	5x5"	27.2	0.9	120	10	BG

HOLDit!® DATA DISK POCKETS

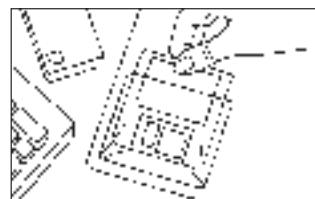

- Ideal for presentations, electronic catalogs, interactive sales materials, data filing, etc.
- High quality vinyl pocket with self-adhesive backing
- Adhesive used on this HOLDIT!® product is specially formulated to be compatible with all materials, including PVC vinyl (binders). It will not become gummy or seep out from underneath edges
- Packed 10 per poly bag in display carton

ITEM NO.	ID NO. 83086 UPC	DESCRIPTION	CTN WT LBS	CTN CUBE	CTN QTY	MIN ORD QTY	U O M
21700	21700 5	3½" Data Disk Pockets 10/Bag	17.8	0.8	120	10	BG



HOLDit!® LABELING & PRESENTATION ACCESSORIES

HOLDit!® BINDER LABEL HOLDERS

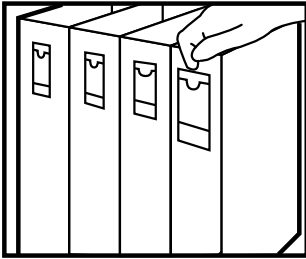

- High quality non-reflective vinyl with self-adhesive backing
- Reversible paper inserts
- Available in 4 sizes
- Ideal for binders, shelves, file drawers, report covers, etc.
- Packed in poly bag in display carton
- Adhesive used on this HOLDIT!® product is specially formulated to be compatible with all materials, including PVC vinyl (binders). It will not become gummy or seep out from underneath edges
- FREE software templates available at www.cardinalbrands.com/support

ITEM NO.	ID NO. 83086 UPC	DESCRIPTION	PRODUCT DIMENSION	CTN WT LBS	CTN CUBE	CTN QTY	MIN QTY	U ORD M
21800	21800 2	Label Holders, 8/Bag	¾x3"	5.3	0.4	120	10	BG
21810	21810 1	Label Holders, 12/Bag	1x3"	7.8	0.5	120	10	BG
21820	21820 0	Label Holders, 12/Bag	1½x3"	9.6	0.4	120	10	BG
21830	21830 9	Label Holders, 6/Bag	2¾x4"	10.5	0.4	120	10	BG

HOLDit!® BUSINESS CARD POCKETS

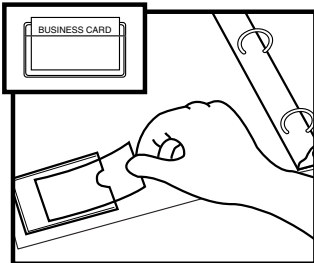

- High quality vinyl with self-adhesive backing
- Available in top or side opening styles
- Packed 10 per poly bag in display carton
- Adhesive used on this HOLDIT!® product is specially formulated to be compatible with all materials, including PVC vinyl (binders). It will not become gummy or seep out from underneath edges.

ITEM NO.	ID NO. 83086 UPC	DESCRIPTION	PRODUCT DIMENSION	CTN WT LBS	CTN CUBE	CTN QTY	MIN QTY	U ORD M
21500	21500 1	Top Load, 10/Bag	3¾x2¾"	12.2	0.7	120	10	BG
21510	21510 0	Side Load, 10/Bag	3¾x2¾"	12.6	0.7	120	10	BG

HOLDit!® BINDER INSERT STRIPS

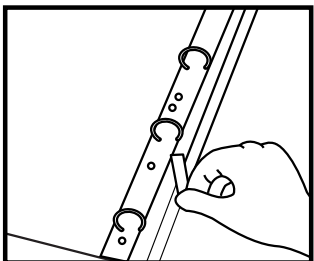

- Easy way to add unpunched materials to binders
- Clear adhesive strip is strong and multi-hole punched to fit variety of binder ring styles
- Simply peel away cover strip to reveal adhesive and press in place
- Packed 25 per poly bag in display carton

ITEM NO.	ID NO. 83086 UPC	DESCRIPTION	PRODUCT DIMENSION	CTN WT LBS	CTN CUBE	CTN QTY	MIN QTY	U ORD M
21110	21110 2	Adhesive Binder Insert Strips, 25/Bag	11x¾"	13.6	0.8	120	10	BG

HOLDit!® SELF-ADHESIVE POCKETS

NEW HOLDit!® SELF-ADHESIVE FULL PAGE POCKET

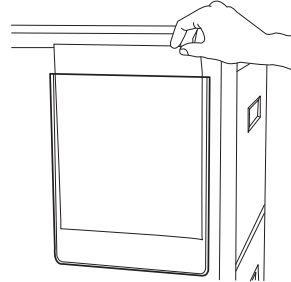

- High quality, vinyl pocket with self-adhesive backing
- Adhesive used on this HOLDIT!® product is specially formulated to be compatible with all materials, including PVC vinyl (binders). It will not become gummy or seep out from underneath edges.
- Holds up to 8½ x 11" sheets; perfect for directories, file cabinets, notices, signs or job tickets

ITEM NO.	ID NO. 83086 UPC	DESCRIPTION	PRODUCT DIMENSION	CTN WT LBS	CTN CUBE	CTN QTY	MIN QTY	U ORD M
21910	21910 8	Top Load, 10/Bag	8½ x 11½"	39.5	1.0	50	50	BG

NEW HOLDit!® SELF-ADHESIVE PORTFOLIO POCKET

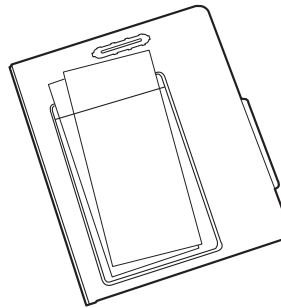

- High quality, vinyl pocket with self-adhesive backing
- Adhesive used on this HOLDIT!® product is specially formulated to be compatible with all materials, including PVC vinyl (binders). It will not become gummy or seep out from underneath edges.
- Perfect for cards, sheets, warranties and brochures.

ITEM NO.	ID NO. 83086 UPC	DESCRIPTION	PRODUCT DIMENSION	CTN WT LBS	CTN CUBE	CTN QTY	MIN QTY	U ORD M
21920	21920 7	Top Load, 10/Bag	5¼ x 8¾"	40.6	1.1	120	120	BG

NEW HOLDit!® SELF-ADHESIVE HALF PAGE POCKET

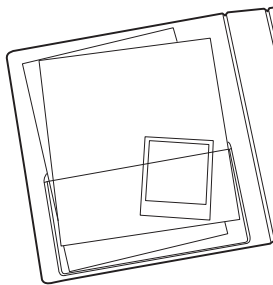

- High quality, vinyl pocket with self-adhesive backing
- Adhesive used on this HOLDIT!® product is specially formulated to be compatible with all materials, including PVC vinyl (binders). It will not become gummy or seep out from underneath edges.
- Ideal as binder pockets; these pockets can be used virtually anywhere. Add to a binder or folder for additional document storage

ITEM NO.	ID NO. 83086 UPC	DESCRIPTION	PRODUCT DIMENSION	CTN WT LBS	CTN CUBE	CTN QTY	MIN QTY	U ORD M
21930	21930 6	Top Load, 10/Bag	9 x 5¾"	40.6	1.1	120	120	BG

MERCHANDISE DISPLAYS

RING BINDER DISPLAY CENTER



- Rotating display facilitates maximum shopper viewing
- Four shelves on front and back are sized to hold binders – Total 16 feet of shelf space
- Eight clear acrylic pockets on the sides hold OneStep® Indexes, ReportPro™ Report covers, ShowFile™ Display Books, etc.
- Made of heavyweight acrylic, with opaque acrylic sign
- Occupies only 5 square feet of floor space

ITEM NO.	ID NO. 83086 UPC	DESCRIPTION	PRODUCT DIMENSION	CTN WT LBS	CTN CTN CUBE	MIN QTY	U ORD QTY	O M
99000D1	99002 1	Ring Binder Display Center	30"Wx24"Dx 56"H	102.4	N/A	0.5	1	EA

notes

A series of horizontal dotted lines for writing notes.